



COMMERCIAL PARTS



Trailer **CATALOGUE** 2nd Edition







SAC Commercial Parts supplies affordable, quality replacement parts for all leading European and Japanese heavy and medium commercial vehicles as well as aftermarket parts and accessories for trailers, buses, transporters and light commercial vehicles.

SAC is a ONE-STOP-SHOP and therefore our product portfolio further includes a comprehensive selection of Lubricants and Automotive Fluids of unparalleled quality. For the convenience of our customers we also import a superior range of OEM authorised 12-Volt maintenance-free batteries ideally suited to keep up with the increased energy demands of the electronics-loaded vehicles of today.

Quality, compatibility and availability of products are paramount to our procurement decision-making process and nowhere is this more evident than with our range of TRAILER parts and components as contained here within. Should you require additional information contact your nearest branch or visit www.sactrucks.co.za to enquire. Prices are available on request, Ts and Cs apply.





In the Spotlight SAC Commercial Parts strives to develop sustainable, long-term and mutually beneficial partnerships with both local and global industry experts renowned for the quality, affordability, compatibility and availability of their OE specified replacement parts.

One such proud association is with Mansons International Pvt. Ltd, a leading global components manufacturer and supplier to the OEM, Tier 1, Commercial Vehicle and TRAILER aftermarket industries. Mansons, headquartered in Mumbai, India, has been providing products and services of exceptional value, performance and reliability for more than 66 years; a track record we know we can rely on to meet the component needs of our valued customers.

The Mansons logo on a product is your assurance of the high quality standards they meet and exceed in the design, development and production of every single component in their vast product range, a selection of which is included here within.





INDEX

- 10** Parts on Offer
- 12** Brakes
 - 13** Brake Pads
 - 13** Brake Disc
 - 14** Brake Drum
 - 15** Shoe & Lining
 - 21** Caliper
 - 22** Z & S Cam
 - 27** Slack Adjuster
 - 28** Springs
- 31** Air
 - 32** Air Booster
 - 33** Bellow & Bag
 - 36** Air Suzi
 - 37** Air Valves
 - 40** Air System
 - 57** Hoses
- 61** Electrical
- 66** Body
- 71** Lights

77 Wheel & Hub

80 Hub

84 Bearings

93 Studs & Nuts

101 Suspension

105 Leaf Spring

107 Axle

111 Rocker Box

113 Radius Rod

114 Hangers

116 Wear Plate

118 Bushes

122 U-Bolt

125 Fasteners & Connectors

132 Chassis

132 Landing Leg

132 5th Wheel

138 King Pin

140 Shocks

141 Universal

156 Why SAC?

157 FAQ

158 Disclaimer



INDEX

Office Hours
Mon - Fri 07h00 to 16h45
Sat - 08h00 to 13h00

OUR BRANCHES

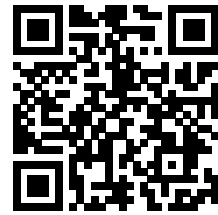

SCAN ME TO MAKE AN ENQUIRY



Workshop

97 Park Avenue North,
Highway Business Park,
Rooihuiskraal, Centurion,
Gauteng, 0157

Tel: +27 (0) 12 687 3600
Email: info@sactrucks.co.za



Used Parts

97 Park Avenue North,
Highway Business Park,
Rooihuiskraal, Centurion,
Gauteng, 0157

Tel: +27 (0) 12 687 3600
A/H: +27 (0) 63 690 0450
Email: usedpartsales@sactrucks.co.za



Head Office

97 Park Avenue North,
Highway Business Park,
Rooihuiskraal, Centurion,
Gauteng, 0157

Tel: +27 (0) 12 687 3600
A/H: +27 (0) 12 687 3600
Email: parts.pta@sactrucks.co.za



Durban

Unit 8 - 12, Redlyn Business
Park, 5 Riverhorse Place,
Riverhorse Valley, Durban,
Kwazulu-Natal, 4017

Tel: +27 (0) 31 512 5063
A/H: +27 (0) 71 185 9530
Email: parts.dbn@sactrucks.co.za



Alrode

Unit 18, Newmarket
Commercial Park,
39 Heidelberg Avenue,
Alrode, Alberton, Gauteng,
1449

Tel: +27 (0) 10 880 1364
A/H: +27 (0) 10 880 1364
Email: parts.alr@sactrucks.co.za



Vereeniging

21 Telford Street,
Duncanville, Vereeniging,
Gauteng, 1939

Tel: +27 (0) 16 931 1022
A/H: +27 (0) 16 931 1022
Email: parts.vdb@sactrucks.co.za



Nelspruit

31 Waterfall Avenue,
Riverside, Nelspruit,
Mpumalanga, 1201

Tel: +27 (0) 13 010 1279
A/H: +27 (0) 76 384 8381
Email: parts.nlp@sactrucks.co.za



Middelburg

8 Summer Street, SAE
Business Park, New
Industrial Area, Middelburg,
Mpumalanga, 1055

Tel: +27 (0) 13 244 1477
A/H: +27 (0) 13 244 1477
Email: parts.mdb@sactrucks.co.za



Polokwane

Unit 1, Bonanza Industrial
Park, 5 Kalsiet Street,
Magna Via, Polokwane,
Limpopo, 0700

Tel: +27 (0) 15 298 8044
A/H: +27 (0) 60 981 5568
Email: parts.plk@sactrucks.co.za



Klerksdorp

Cnr Meteor & Chromium
Road, Uraniaville,
Klerksdorp, North West,
2571

Tel: +27 (0) 18 469 9300
A/H: +27 (0) 76 053 0409
Email: parts.kld@sactrucks.co.za



Boksburg

Unit 2, 4 Herman Pieters
Road, Hughes, Boksburg,
Gauteng, 1459

Tel: +27 (0) 11 826 4866
A/H: +27 (0) 11 826 4866
Email: parts.bkb@sactrucks.co.za



Welkom

3 Nourse Street,
Reitzpark, Welkom,
Free State, 9459

Tel: +27 (0) 57 355 3251
A/H: +27 (0) 52 558 5572
Email: parts.wel@sactrucks.co.za



Bloemfontein

Unit 1, 14A Lessing Avenue,
Estoire, Bloemfontein,
Free State, 9323

Tel: +27 (0) 51 433 1278
A/H: +27 (0) 71 613 6755
Email: parts.bfn@sactrucks.co.za



Pomona

189 High Road, Bredell AH,
Kempton Park, Gauteng,
1619

Tel: +27 (0) 10 880 4601
A/H: +27 (0) 76 847 0392
Email: parts.pom@sactrucks.co.za



Port Elizabeth

118 Burman Road,
Deal Party, Port Elizabeth,
Eastern Cape, 6210

Tel: +27 (0) 41 880 0045
A/H: +27 (0) 41 880 0045
Email: parts.pe@sactrucks.co.za



Cape Town

Unit 3, Concorde Park, 33
Concorde Crescent,
Airport City, Cape Town,
Western Cape, 7490

Tel: +27 (0) 21 385 0460
A/H: +27 (0) 21 385 0460
Email: parts.cpt@sactrucks.co.za



Krugersdorp

7 Reseda street, Boltonia,
Krugersdorp, Gauteng, 1739

Tel: +27 (0) 10 880 0012
A/H: +27 (0) 10 880 0012
Email: parts.kdp@sactrucks.co.za



Paarl

Unit 2, Cnr E.K. Green &
Kaplan, Charleston Hill,
Paarl, Western Cape, 7646

Tel: +27 (0) 21 879 5650
A/H: +27 (0) 21 879 5650
Email: parts.prl@sactrucks.co.za



Centurion

97 Park Avenue North,
Highway Business Park,
Rooihuiskraal, Centurion,
Gauteng, 0157

Tel: +27 (0) 12 687 3600
A/H: +27 (0) 12 687 3600
Email: parts.pta@sactrucks.co.za



East London

Unit 5, 32 Dyer St, Arcadia,
East London, 5201

Tel: +27 (0) 43 880 0043
A/H: +27 (0) 72 633 0291
Email: parts.esl@sactrucks.co.za



Next Branch

**COMING
SOON!**

PARTS ON OFFER

Filters



Lubricants



Brakes



Clutch



Batteries



Air

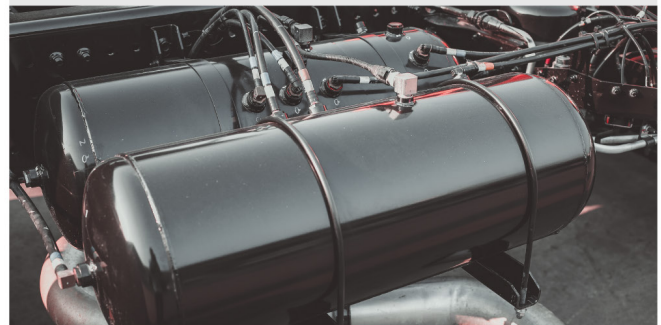

Electrical

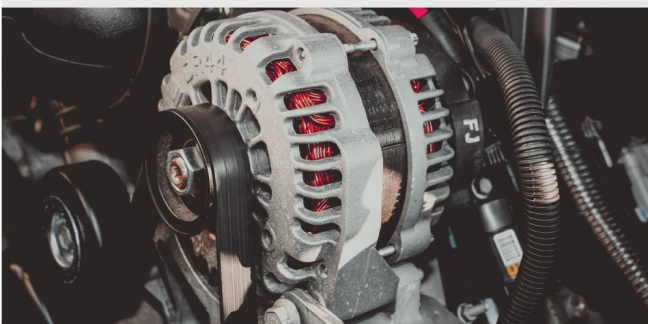

Universal Parts



Cooling System



Hydraulic System



Fuel System



Turbo & Exhaust



Hub & Steering



Body



Engine Internal



Engine External

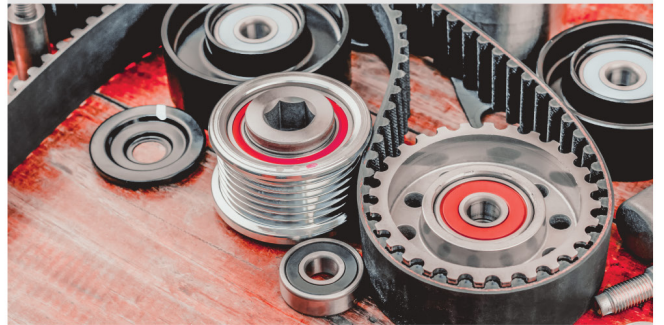

Suspension



Gearbox

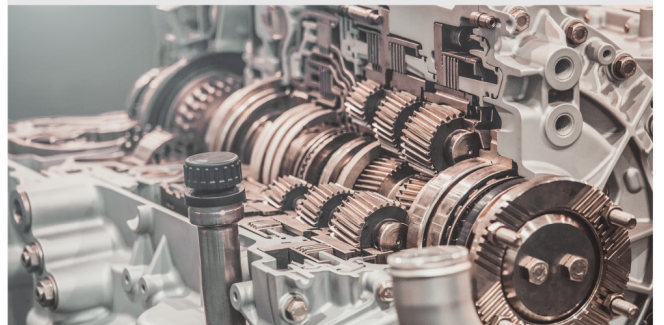

BRAKES



RELATED COMPONENTS

Z & S - CAM

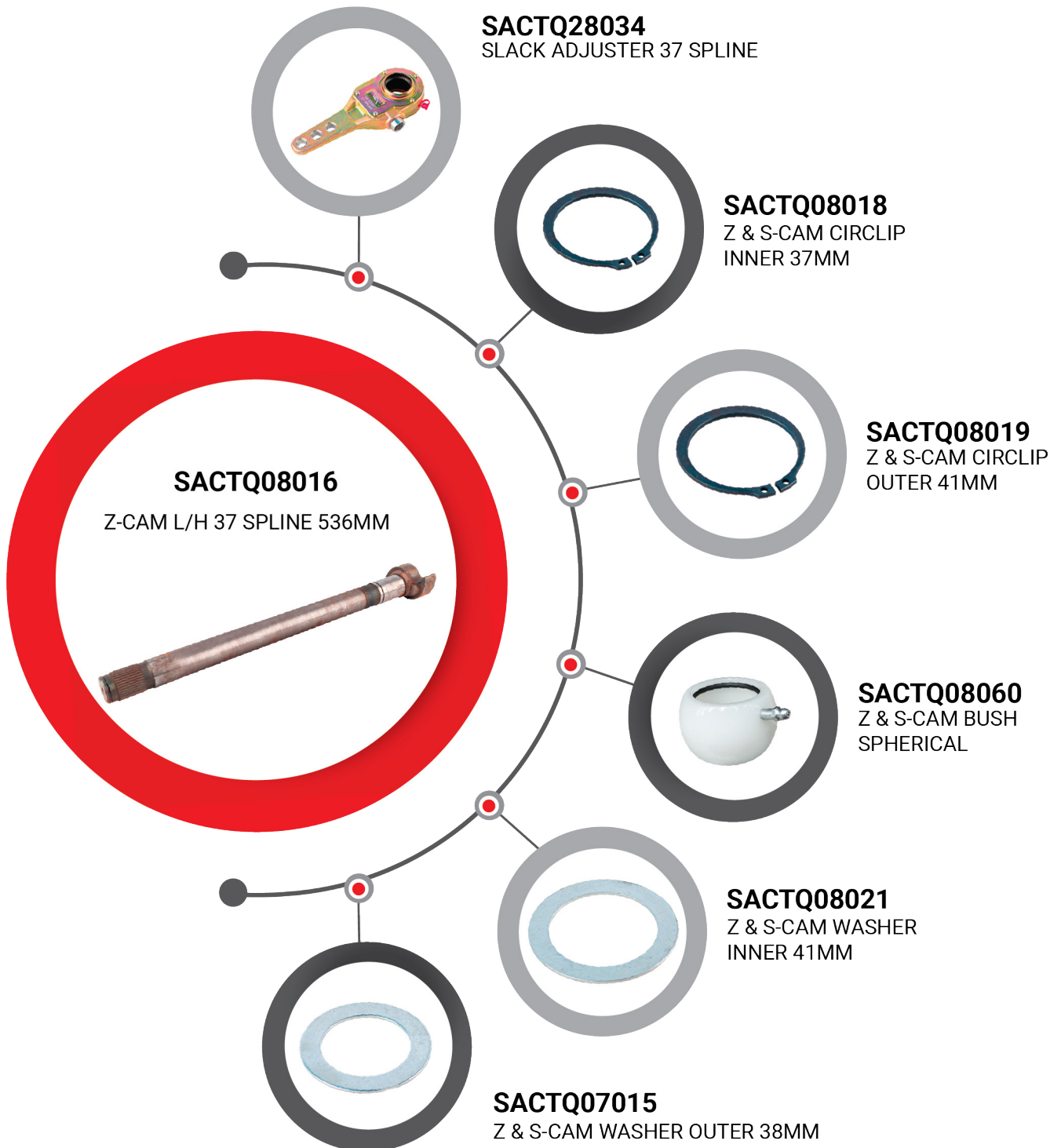





BRAKES



SAC NO.	IMAGE	DESCRIPTION	SUITABLE FOR I.E.
BRAKE PADS			
1014005		AFTERMARKET FRONT/REAR BRAKE PADS	BPW
1014002		AFTERMARKET BRAKE PAD KIT	BPW
SACPADSBPW01		OE BRAKE PADS	BPW
SACTRAIL523		OE BRAKE PAD KIT	HOLLAND
BRAKE DISC			
SAC070.270		OE REAR BRAKE DISC	BPW
SACTRAIL508		AFTERMARKET BRAKE DISC ECO	BPW
SACTRAIL070		AFTERMARKET REAR BRAKE DISC	BPW
SACTRAIL507		AFTERMARKET REAR BRAKE DISC	BPW

BRAKES

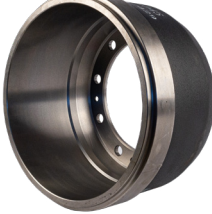

SAC NO.	IMAGE	DESCRIPTION	SUITABLE FOR I.E.
SACTRAIL522		OE FRONT/REAR BRAKE DISC	HOLLAND
1014105		AFTERMARKET REAR BRAKE DISC	BPW
BRAKE DRUM			
SACPROA030		AFTERMARKER BRAKE DRUM 403 PROPAR	HENRED
SACTQ06039		AFTERMARKET BRAKE DRUM 518	SWIFT
SACTQ06045		AFTERMARKET BRAKE DRUM FOR OUTBOARD	PROTEA
SACTQ24375		AFTERMARKET BRAKE DRUM 375 ECO	BPW
SACTQ24376		AFTERMARKET BRAKE DRUM LOWBED	BPW
SACTQ24371		AFTERMARKET BRAKE DRUM ECO/ECO PLUS	BPW

BRAKES



SAC NO.	IMAGE	DESCRIPTION	SUITABLE FOR I.E.
SACTQ24372		AFTERMARKET BRAKE DRUM ECO/ECO PLUS	BPW
SACHENRED018		AFTERMARKET REAR BRAKE DRUM 403 PROPAR	HENRED
SACTRAIL505		AFTERMARKET BRAKE DRUM 403 PROPAR	HENRED
SACTRAIL520		OE BRAKE DRUM	HOLLAND
SACTRAIL0066		AFTERMARKET BRAKE DRUM ECO/ECO PLUS	BPW
SACBPW0008		OE BRAKE DRUM	BPW
SACBPW0015		AFTERMARKET BRAKE DRUM 375 ECO	BPW
SHOE & LINING			
SACBPWBC36BOM		AFTERMARKET BRAKE SHOE BC36 COMPLETE	BPW

BRAKES



SAC NO.	IMAGE	DESCRIPTION	SUITABLE FOR I.E.
SACTQ08064A		AFTERMARKET BRAKE SHOE 4515 COMPLETE	HENRED
SACTQ07005		AFTERMARKET BRAKE SHOE UNLINED	SWIFT
SACTRAIL0007		AFTERMARKET BRAKE SHOE 4515 UNLINED	HENRED
SACBPW0016		AFTERMARKET BRAKE SHOE BC36 UNLINED	BPW
SACTQ27110		AFTERMARKET REAR BRAKE SHOE KIT	SAMTOR
SACTRAIL4043		AFTERMARKET BRAKE SHOE KIT 4515	HENDRED
SACBPW06800		AFTERMARKET BRAKE SHOE REPAIR KIT	BPW
SACBPWS074AA		AFTERMARKET BRAKE SHOE ROLLER KIT BC36 ECO PLUS	BPW

BRAKES



SAC NO.	IMAGE	DESCRIPTION	SUITABLE FOR I.E.
CK1015		AFTERMARKET BRAKE SHOE ROLLER KIT BC36 ECO PLUS	BPW
SACTRAIL0008		AFTERMARKET BRAKE SHOE SPRING POST	HENRED
SACTQ08061		AFTERMARKET BRAKE SHOE ANCHOR PIN PROPAR	HENRED
SACTQ17007		AFTERMARKET BRAKE SHOE ROLLER	HENRED
SACTQ17028		AFTERMARKET BRAKE SHOE ANCHOR PIN + ROLLER	HENRED
SACBPWH005		OE BRAKE SHOE ANCHOR PIN BUSH	BPW
300.526		AFTERMARKET BRAKE SHOE ANCHOR PIN BUSH	HENRED
SACTQ08024		AFTERMARKET BRAKE SHOE ANCHOR PIN BUSH	HENRED

BRAKES



SAC NO.	IMAGE	DESCRIPTION	SUITABLE FOR I.E.
SACTQ27109		AFTERMARKET BRAKE SHOE ANCHOR PIN BUSH	SAMTOR
SACTQ27111A		AFTERMARKET BRAKE SHOE ANCHOR PIN	SAMTOR
SACTQ08003		AFTERMARKET BRAKE SHOE ANCHOR PIN	HENRED
SACTQ27131		AFTERMARKET BRAKE SHOE SPRING POST 12 X 95MM	SWIFT
SACTQ27107		AFTERMARKET BRAKE SHOE PIN WEDGE PLATE	SAMTOR
SACBPWH037		OE BRAKE SHOE WEDGE PLATE	BPW
MBL92		AFTERMARKET BRAKE SHOE WEDGE PLATE	BPW
SACTQ08008A		AFTERMARKET BRAKE SHOE ROLLER CLIP	HENRED

BRAKES



SAC NO.	IMAGE	DESCRIPTION	SUITABLE FOR I.E.
SACBPWAS0325		AFTERMARKET BRAKE SHOE ROLLER C-CLIP	BPW
SACTRAIL733		BRAKE SHOE SPRING POST CIRCLIP	UNIVERSAL
SACBPWH077		OE BRAKE SHOE ROLLER CLIP	BPW
SPR007		AFTERMARKET BRAKE SHOE ROLLER CLIP	BPW
SACTQ08009		AFTERMARKET BRAKE SHOE ROLER SPLIT PIN	HENRED
L10		BRAKE SHOE RIVET L10	MULTIBRAND
L15		BRAKE SHOE RIVET L15	MULTIBRAND
L20		BRAKE SHOE RIVET L20	MULTIBRAND

BRAKES



SAC NO.	IMAGE	DESCRIPTION	SUITABLE FOR I.E.
SACTRAIL0021		AFTERMARKET BRAKE LINING KIT 4515 ANCHOR	HENRED
SACTRAIL0022		AFTERMARKET BRAKE LINING KIT 4515 CAM	HENRED
SACTRAIL0028		AFTERMARKET BRAKE LINING KIT 4515 1MM	HENRED
SACTRAIL0026		AFTERMARKET BRAKE LINING 4515 1MM ANCHOR	HENRED
SACTRAIL0027		AFTERMARKET BRAKE LINING 4515 2MM ANCHOR	HENRED
SACTRAIL0029		AFTERMARKET BRAKE LINING KIT 4515 2MM	HENRED
1013001		AFTERMARKET BC36 BRAKE LINING KIT 200MM WITH RIVETS	BPW
SACTRAIL0033		AFTERMARKET BRAKE LINING BC36 STANDARD	BPW

BRAKES



SAC NO.	IMAGE	DESCRIPTION	SUITABLE FOR I.E.
CALIPER			
SACTRAIL4045		AFTERMARKET BRAKE CALIPER COMPLETE L/H SK7	BPW
SACTRAIL4046		AFTERMARKET BRAKE CALIPER COMPLETE R/H SK7	BPW
081070115		OE CALIPER LEVER ROLLER BEARING	BPW
081070102		AFTERMARKET CALIPER BUSH & PIN KIT	BPW
081070113		AFTERMARKET CALIPER LEVER LH/RH	BPW
081070116		AFTERMARKET CALIPER ADJUSTER KIT	BPW
081070128		AFTERMARKET CALIPER LEVER HOUSING	BPW
081070132		AFTERMARKET CALIPER MAJOR REPAIR KIT	BPW









BRAKES



SAC NO.	IMAGE	DESCRIPTION	SUITABLE FOR I.E.
Z & S CAM			
SACTQ21043		AFTERMARKET S-CAM R/H 10 SPLINE 629MM	SWIFT
SACTQ08015		AFTERMARKET S-CAM R/H 37 SPLINE 605MM	HENRED
SACTQ08046		AFTERMARKET S-CAM R/H 37 SPLINE 675MM	HENRED
SACTQ07021		AFTERMARKET S-CAM R/H 7/8 UNF 649MM	SWIFT
SACTQ07025		AFTERMARKET S-CAM R/H 477MM 7/8UNF	HENRED
1013535		AFTERMARKET S-CAM R/H 10 SPLINE 734MM	BPW
1023104		AFTERMARKET S-CAM R/H 10 SPLINE 570MM	PROTEA
1013537		AFTERMARKET S-CAM R/H 10 SPLINE 673MM	BPW

BRAKES



SAC NO.	IMAGE	DESCRIPTION	SUITABLE FOR I.E.
SACTQ27122		AFTERMARKET S-CAM R/H 26 SPLINE 495MM	SAMTOR
1013105		OE S-CAM L/H L=696MM	BPW
1013534		AFTERMARKET Z-CAM L/H 10 SPLINE 734MM	BPW
1013536		AFTERMARKET Z-CAM L/H 10 SPLINE 673MM	BPW
SACSWIF017		AFTERMARKET Z-CAM L/H 27SQ 575MM	SWIFT
SACTQ08016		AFTERMARKET Z-CAM L/H 37 SPLINE 536MM	HENRED
1023105		AFTERMARKET Z-CAM L/H 10 SPLINE 570MM	PROTEA
SACTQ08014		AFTERMARKET Z-CAM L/H 37 SPLINE 605MM	HENRED

BRAKES



SAC NO.	IMAGE	DESCRIPTION	SUITABLE FOR I.E.
SACTQ08045		AFTERMARKET Z-CAM L/H 37 SPLINE 675MM	HENRED
SACTQ07024		AFTERMARKET Z-CAM L/H 7/8 UNF 477MM	HENRED
SACTQ07020		AFTERMARKET Z-CAM L/H 7/8 UNF 649MM	SWIFT
SACTQ27121		AFTERMARKET Z-CAM L/H 26 SPLINE 495MM	SAMTOR
SACTQ27112		AFTERMARKET Z & S-CAM REPAIR KIT	SAMTOR
SACT0001		OE Z & S-CAM REPAIR KIT	BPW
SACBPWH046A		AFTERMARKET Z & S-CAM REPAIR KIT	BPW
SACTQ08021		AFTERMARKET Z & S-CAM INNER WASHER 41MM	HENRED

BRAKES











SAC NO.	IMAGE	DESCRIPTION	SUITABLE FOR I.E.
SACTQ07015		AFTERMARKET Z & S-CAM WASHER OUTER 38MM	HENRED
SACTQ08019		AFTERMARKET Z & S-CAM CIRCLIP OUTER 41MM	HENRED
SACTQ08018		AFTERMARKET Z & S-CAM CIRCLIP INNER 37MM	HENRED
SACTQ07004		AFTERMARKET Z & S-CAM BUSH	SWIFT
SACTQ08100		AFTERMARKET Z & S-CAM BUSH 41X51X38MM	HENRED
400.115		AFTERMARKET Z & S-CAM BUSH 41X51X38MM	HENRED
MPB36		AFTERMARKET Z & S-CAM BUSH BRASS	BPW
SACBPWH003		OE Z & S-CAM BUSH BRASS	BPW

SAC NO.	IMAGE	DESCRIPTION	SUITABLE FOR I.E.
SACTQ17101		AFTERMARKET Z & S-CAM BUSH WHITE	SWIFT
SACTQ08020		AFTERMARKET Z & S-CAM BUSH WITH ORING	HENRED
MBP3002		AFTERMARKET Z & S-CAM BUSH STEEL	BPW
SACBPWS015		OE Z & S-CAM BUSH STEEL	BPW
CSB11		AFTERMARKET Z & S-CAM BUSH SPHERICAL	HENRED
SACTQ08031		AFTERMARKET Z & S-CAM BUSH SPHERICAL	HENRED
SACTQ08060		AFTERMARKET Z & S-CAM BUSH SPHERICAL	HENRED
SACTQ17032		AFTERMARKET Z & S-CAM BUSH SPHERICAL	PROTEA

BRAKES



SAC NO.	IMAGE	DESCRIPTION	SUITABLE FOR I.E.
SACTQ19035		AFTERMARKET Z & S-CAM BUSH ASSEMBLY 5 SIDES	SWIFT
SACBPWS017		OE Z & S-CAM BUSH REPAIR KIT	BPW
SACTQ08065		AFTERMARKET Z & S-CAM BUSH ASSEMBLY NEW GEN	HENRED
SLACK ADJUSTER			
SACTRAIL506		AFTERMARKET SLACK ADJUSTER AUTO LH/RH	BPW
1013023		AFTERMARKET SLACK ADJUSTER AUTO LH/RH	BPW
SACTQ28101		AFTERMARKET SLACK ADJUSTER 37 SPLINE AUTO	HENRED
SACTQ28035C		AFTERMARKET SLACK ADJUSTER 28 SPLINE	SWIFT
SACTQ27138		AFTERMARKET SLACK ADJUSTER 26 SPLINE	SAMTOR

SAC NO.	IMAGE	DESCRIPTION	SUITABLE FOR I.E.
SACTQ28032		AFTERMARKET SLACK ADJUSTER 27MM SQUARE	HENRED
SACTQ28033		AFTERMARKET SLACK ADJUSTER 10 SPLINE	BPW
SACTQ28034		AFTERMARKET SLACK ADJUSTER 37 SPLINE	HENRED
SPRINGS			
SACBPW0010		AFTERMARKET BRAKE SHOE RETURN SPRING	BPW
300.068		AFTERMARKET BRAKE SHOE RETRUN SPRING	BPW
SACBPWH082A		OE BRAKE SHOE RETURN SPRING	BPW
SACBPWH082B		OE BRAKE SHOE RETURN SPRING	BPW
SPR001		AFTERMARKET BRAKE SHOE RETRUN SPRING	BPW

BRAKES



SAC NO.	IMAGE	DESCRIPTION	SUITABLE FOR I.E.
SPR002		AFTERMARKET BRAKE SHOE RETRUN SPRING	BPW
SPR005		AFTERMARKET BRAKE SHOE RETRUN SPRING	BPW
SACTRAIL0006		AFTERMARKET BRAKE SPRING SHORT 4.5 X 19 X 157MM	HENRED
SACTQ17040		AFTERMARKET BRAKE SHOE RETURN SPRING SHORT	HENRED
SPR008		AFTERMARKET BRAKE RETURN SPRING SHORT	HENRED
SAC07008		AFTERMARKET BRAKE SHOE SPRING LONG 260MM	BPW
SACTQ07018		AFTERMARKET BRAKE RETURN SPRING LONG	SWIFT
SACTQ08010		AFTERMARKET BRAKE SHOE RETURN SPRING LONG	HENRED

BRAKES



SAC NO.	IMAGE	DESCRIPTION	SUITABLE FOR I.E.
1013053		AFTERMARKET BRAKE SHOE SPRING LONG 260MM	BPW
1013061		AFTERMARKET BRAKE SHOE SPRING LONG 265MM	BPW
SACBPWH058		OE BRAKE SHOE RETURN SPRING	BPW
SACBPWS082A		AFTERMARKET BRAKE SHOE SPRING EYE TYPE	BPW
300.085		AFTERMARKET BRAKE SHOE REPAIR KIT	BPW
1013065		AFTERMARKET RETURN SPRING WITH HOOK 125MM	BPW
1013064		AFTERMARKET BRAKE SHOE SPRING EYE TYPE	BPW



AIR





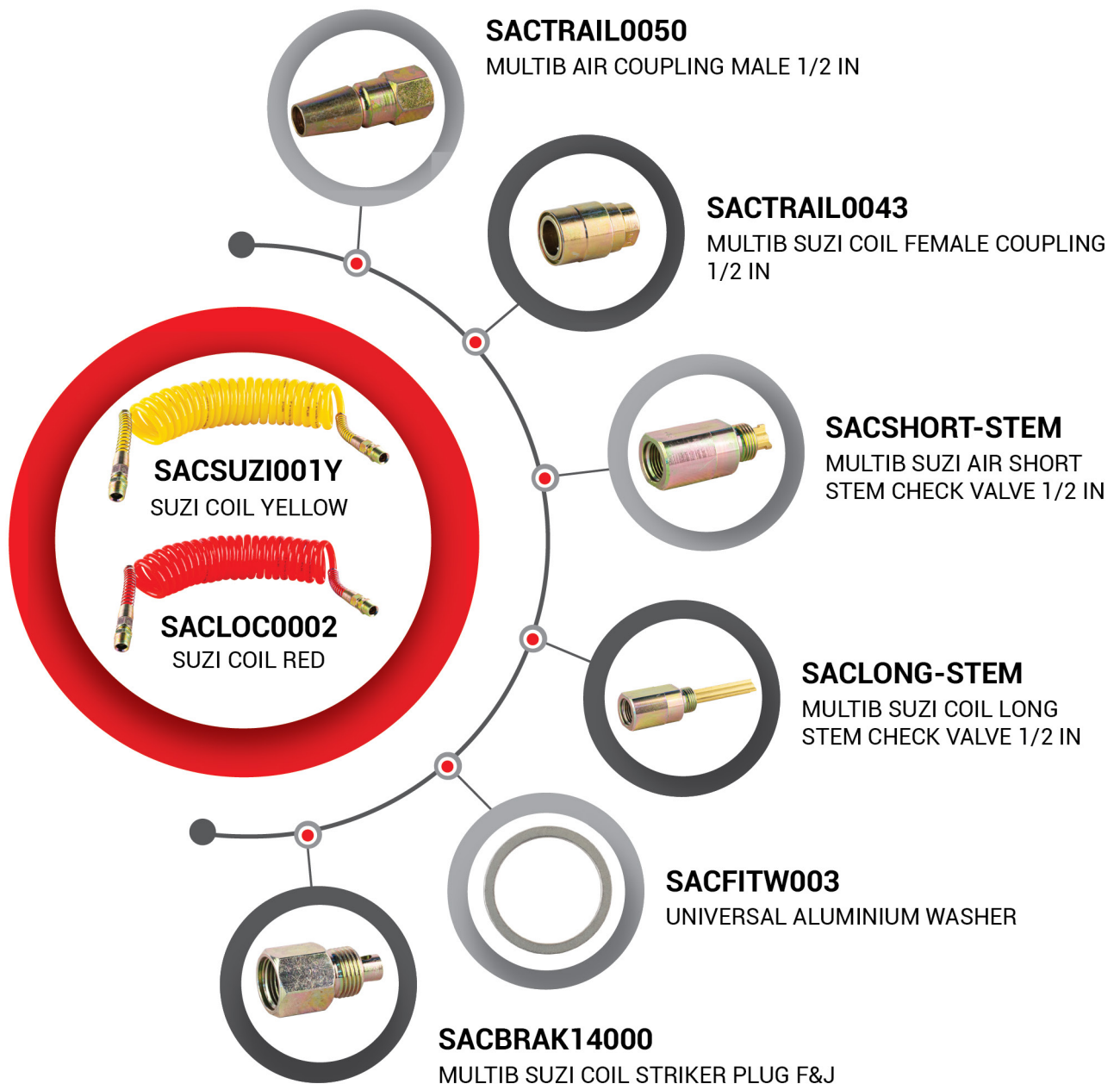



RELATED COMPONENTS RED & YELLOW SUZIS





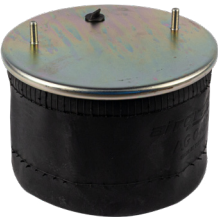



SAC NO.	IMAGE	DESCRIPTION	SUITABLE FOR I.E.
AIR BOOSTER			
SACBPW0012		OE BRAKE BOOSTER T16/24	BPW
SACBPW0011		AFTERMARKET BRAKE BOOSTER T16/24 DISC BRAKE	BPW
S200014		AFTERMARKET BRAKE BOOSTER T24/24	HENRED
SACBB001		AFTERMARKET BRAKE BOOSTER T24/30	HENRED
SACBB003		AFTERMARKET BRAKE BOOSTER T24	BPW
SACBB010		AFTERMARKET BRAKE BOOSTER T30	BPW
SACBB007		AFTERMARKET BRAKE BOOSTER T30/30	HENRED
SAC094.024		AFTERMARKET BRAKE BOOSTER T24/30 LONG STROKE	BPW

SAC NO.	IMAGE	DESCRIPTION	SUITABLE FOR I.E.
SACTRAIL1698		AFTERMARKET BRAKE BOOSTER T24/30 LONG STROKE	BPW
SACTRAIL1699		AFTERMARKET BRAKE BOOSTER T24/30	HENRED
SACTRAIL109		AFTERMARKET BRAKE BOOSTER T24/30	HENRED
SACBBBPW		OE BRAKE BOOSTER T24/30 LONG STROKE	BPW
SACMISC029		AFTERMARKET BRAKE BOOSTER DIAPHRAGM T24	BPW
SACMISC030		AFTERMARKET BRAKE BOOSTER DIAPHRAGM T30	BPW
SACBPWAS01610A		OE BRAKE BOOSTER BRACKET	BPW
BELLOW & BAG			
SACAIRBWEW		AFTERMARKET AIR BELLOW 2 STUD	HENRED/WEWELER

SAC NO.	IMAGE	DESCRIPTION	SUITABLE FOR I.E.
SACAIRBWEW9T		AFTERMARKET AIR BELLOW 2 STUD 9 TON	HENRED/WEWELER
SACT0005		OE AIR BELLOW 1 INLET PORT	HENDRICKSON
SACAIRB30		AFTERMARKET AIR BELLOW TYPE 30 LONG	BPW
SACAIRB30K		AFTERMARKET AIR BELLOW TYPE 30K SHORT	BPW
SACAIRB36		AFTERMARKET AIR BELLOW TYPE 36 LONG	BPW
SACAIRB36K		AFTERMARKET AIR BELLOW TYPE 36K SHORT	BPW
SACAIRBH03		AFTERMARKET AIRBAG 1 STUD 1 INLET PORT	HENDRICKSON
SACTRAIL1700		AFTERMARKET SWIVEL AIRBAG	HENRED/WEWELER

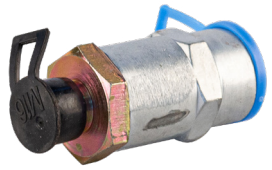
SAC NO.	IMAGE	DESCRIPTION	SUITABLE FOR I.E.
SACAIRBH01		AFTERMARKET AIR BELLOW 2 STUD 1 PORT	HENDRICKSON
SACAIRBWEW01		AFTERMARKET AIR BELLOW 4 STUD	HENRED/WEWELER
S200003		AFTERMARKET AIR BELLOW TYPE 36K SHORT	BPW
S200004		AFTERMARKET AIR BELLOW TYPE 30 LONG	BPW
S200005		AFTERMARKET AIR BELLOW TYPE 30K SHORT	BPW
S200006		AFTERMARKET AIR BELLOW TYPE 36 LONG	BPW
SACTQ30140		AFTERMARKET AIR BELLOW 2 STUD	HENRED
SACSAF0001		AFTERMARKET AIR BELLOW M12X1.75 M22X1.5	SAF







SAC NO.	IMAGE	DESCRIPTION	SUITABLE FOR I.E.
SACTRAIL2211		AFTERMARKET DOUBLE AIR BELOW	HENRED/WEWELER
SACTRAIL100		AFTERMARKET AIR BAG BASE PLATE KIT	AFRIT
SACTRAIL0034		OE AIR BELLOW BOLT M16X65	BPW
AIR SUZI			
SACLOC0002		SUZI AIR COIL PUR HI-PERFORMANCE RED COMPLETE	MULTIBRAND
SACTRAIL901R		SUZI AIR COIL PUR HI-PERFORMANCE RED COMPLETE	MULTIBRAND
SACSUZI001Y		SUZI AIR COIL PUR HI-PERFORMANCE YELLOW	MULTIBRAND
TRAILLINK0010		SUSPENSION SPRING & LOOP	MULTIBRAND
SACMUL0020		METAL STOWING RACK & MOUNTING BOLTS	MULTIBRAND

SAC NO.	IMAGE	DESCRIPTION	SUITABLE FOR I.E.
TRAILLINK0011		TRAILER SUZI BRACKET ASSEMBLY	MULTIBRAND
AIR VALVES			
SACHYTV001A		AFTERMARKET DOP 19 TIP VALVE	BPW
SACCHECK02		AFTERMARKET CHECK VALVE M 22 KNORR	BPW
SACCHECK04		AFTERMARKET CHECK VALVE M 22 KNORR	BPW
SACCHECK05		AFTERMARKET CHECK VALVE 1/2	BPW
SACLEV01		LEVELING VALVE	UNIVERSAL
SACTQLS03		AFTERMARKET LOAD SENSING VALVE	HENRED
SACLS02		AFTERMARKET LOAD SENSING VALVE	BPW





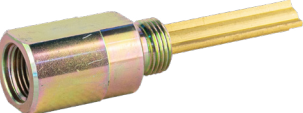

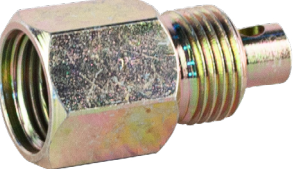
SAC NO.	IMAGE	DESCRIPTION	SUITABLE FOR I.E.
SACLS03		AFTERMARKET LOAD SENSING VALVE	HENRED
SACCHARG01		AFTERMARKET PRESSURE LIMITING VALVE	BPW
SACQR01		AFTERMARKET QUICK RELEASE VALVE M22	HENRED
SACQR02		AFTERMARKET QUICK RELEASE VALVE 1/2 X 3/8	HENRED
SACREV02		AFTERMARKET RELAY VALVE SQ M22	BPW
SACREV04		AFTERMARKET RELAY VALVE ABS	BPW
SACREV05		AFTERMARKET RELAY VALVE SQ M16	BPW
SACREV012		AFTERMARKET RELAY VALVE RE6	BPW

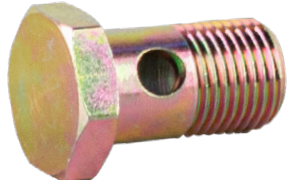

SAC NO.	IMAGE	DESCRIPTION	SUITABLE FOR I.E.
SACSHUT01		AIR SHUT OFF COCK M22	MULTIBRAND
SACINLINE01		AFTERMARKET INLINE FILTER ASSEMBLY	BPW
SACHYTV001AB		AFTERMARKET SIDE TIPPER VALVE DUEL	BPW
SACHYTV003		AFTERMARKET 3 WAY VALVE 1/2	BPW
SACK004236		ABS TRAILER MODULE	MULTIBRAND
SACTRAIL4SC2		AFTERMARKET ABS TRAILER VALVE 4S/2M COMBO	HENRED
SACTRAIL732		EBS TRAILER MODULE	MULTIBRAND
SACK019312		EBS TRAILER MODULE	MULTIBRAND

SAC NO.	IMAGE	DESCRIPTION	SUITABLE FOR I.E.
SACTRAIL1705		DIRECTIONAL CONTROL VALVE	MULTIBRAND
SACTRAIL510		MODULATING ABS VALVE 2 PORT	MULTIBRAND
DRAIN02		AFTERMARKET DRAIN VALVE AUTO	BPW
SACDRAIN03		AFTERMARKET DRAIN VALVE M22	BPW
SACLEV01KG		LEVELING VALVE	UNIVERSAL
S980003		TOGGLE LEVER VALVE COMPLETE WITH FITTINGS	UNIVERSAL
AIR SYSTEM			
SACLINKRUB01		AFTERMARKET AIR LINKAGE RUBBER LONG	BPW
SACLINKRUB02		AFTERMARKET AIR LINKAGE RUBBER P-TYPE	BPW



SAC NO.	IMAGE	DESCRIPTION	SUITABLE FOR I.E.
TANK60L		AIR RESERVOIR TANK 60L	UNIVERSAL
SACFITW003		ALUMINIUM WASHER	UNIVERSAL
SACTRAIL0043		SUZI COIL FEMALE COUPLING 1/2 IN	MULTIBRAND
SACTRAIL0050		AIR COUPLING MALE 1/2"	MULTIBRAND
SACLONG-STEM		SUZI COIL LONG STEM CHECK VALVE 1/2 IN	MULTIBRAND
SACSHORT-STEM		SUZI COIL SHORT STEM CHECK VALVE	MULTIBRAND
SACBRAK1200		AIR COUPLING DUST COVER	MULTIBRAND
SACBRAK14000		SUZI COIL STRIKER PLUG F & J	UNIVERSAL

SAC NO.	IMAGE	DESCRIPTION	SUITABLE FOR I.E.
SACFITP005		AIR VALVE PLUG STEEL 1/4"	MULTIBRAND
SACFITP004		AIR VALVE PLUG STEEL 1/2"	MULTIBRAND
SACFITP003		AIR VALVE PLUG STEEL 3/8"	MULTIBRAND
SACFITP002		AIR VALVE PLUG STEEL M16	MULTIBRAND
SACFITP002A		AIR VALVE PLUG STEEL M14	MULTIBRAND
SACFITP001		AIR VALVE PLUG STEEL M22	MULTIBRAND
SACFIBJ003A		BANJO BOLT SINGLE M12	MULTIBRAND
SACFIBJ004A		BANJO BOLT SINGLE M14	MULTIBRAND



SAC NO.	IMAGE	DESCRIPTION	SUITABLE FOR I.E.
SACFIBJ004AB		BANJO BOLT DOUBLE M14	MULTIBRAND
SACFIBJ001		BANJO BOLT SINGLE M16	MULTIBRAND
SACFIBJ003		BANJO BOLT DOUBLE M12	MULTIBRAND
SACFIBJ002		BANJO BOLT DOUBLE M16	MULTIBRAND
SACFIBJ004B		BANJO TAIL M16 X 12MM	MULTIBRAND
SACFIBJ004		BANJO TAIL M12 X 8MM	MULTIBRAND
SACFIBJ004GA		BANJO TAIL M12 X 6MM	MULTIBRAND
SACFIBJ004C		BANJO TAIL M16 X 6MM	MULTIBRAND





SAC NO.	IMAGE	DESCRIPTION	SUITABLE FOR I.E.
SACFIBJ004FC		BANJO TAIL M14 X 10MM	MULTIBRAND
SACFIBJ004FA		BANJO TAIL M14 X 6MM	MULTIBRAND
SACFIBJ004FB		BANJO TAIL M14 X 8MM	MULTIBRAND
SACFIBJ004E		BANJO TAIL M16 X 10MM	MULTIBRAND
SACFIBJ004D		BANJO TAIL M16 X 8MM	MULTIBRAND
SACFIBJ004F		BANJO TAIL M14 X 12MM	MULTIBRAND
SACFITU006A		BULKHEAD FITTING 1/2 X 12MM	MULTIBRAND
SACFITU006C		BULKHEAD FITTING 1/2 X 12MM STEEL	MULTIBRAND



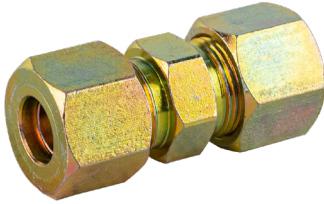

SAC NO.	IMAGE	DESCRIPTION	SUITABLE FOR I.E.
SACFITF001A		CONNECTOR FERRULE 4MM BRASS	MULTIBRAND
SACFITF001		CONNECTOR FERRULE 6MM BRASS	MULTIBRAND
SACFITF002		CONNECTOR FERRULE 8MM BRASS	MULTIBRAND
SACFIT003		CONNECTOR FERRULE 10MM BRASS	MULTIBRAND
SACFITF004		CONNECTOR FERRULE 12MM BRASS	MULTIBRAND
SACFITF009		CONNECTOR FERRULE 15MM BRASS	MULTIBRAND
SACFITI005		CONNECTOR INSERT 1/2" BRASS	MULTIBRAND
SACFITI001		CONNECTOR INSERT 6MM BRASS	MULTIBRAND



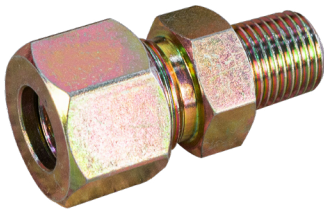
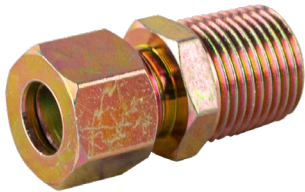
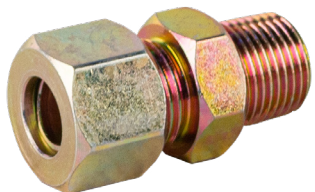

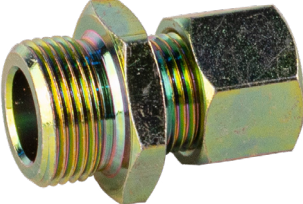
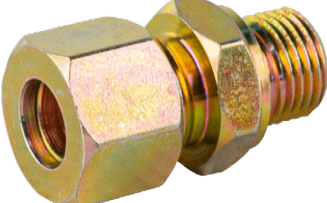
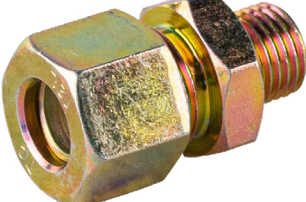
SAC NO.	IMAGE	DESCRIPTION	SUITABLE FOR I.E.
SACFITI002		CONNECTOR INSERT 8MM BRASS	MULTIBRAND
SACFITI003		CONNECTOR INSERT 10MM BRASS	MULTIBRAND
SACFITH005		HOSE ADAPTOR 1/4" BSP X 1/2"	MULTIBRAND
SACFITH006		HOSE ADAPTOR M16 X 1/2"	MULTIBRAND
SACFITR003		REDUCER 3/8" - 1/4"	MULTIBRAND
SACFITR004		REDUCER M22 - M16	MULTIBRAND
SACFITR005		REDUCER M22 - 1/2	MULTIBRAND
SACFITR005A		REDUCER M22 - 1/2	MULTIBRAND

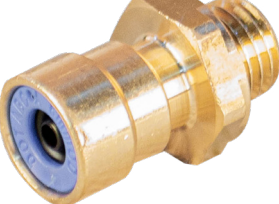

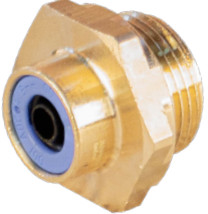

SAC NO.	IMAGE	DESCRIPTION	SUITABLE FOR I.E.
SACFITR005B		REDUCER M22 - 3/8	MULTIBRAND
SACFITR011		REDUCING BUSH M16 - M22	MULTIBRAND
SACFITR012		REDUCER 3/4M - 1/2	MULTIBRAND
SACFITR013		REDUCING BUSH M16 - 3/8	MULTIBRAND
88MLCPI-12		STRAIGHT CONNECTOR PUSH-IN 12MM STEEL	MULTIBRAND
MPUT04		T-TYPE CONNECTOR PUSH-IN 4MM STEEL	MULTIBRAND
985926		T-TYPE CONNECTOR PUSH-IN 6MM STEEL	MULTIBRAND
985928		T-TYPE CONNECTOR PUSH-IN 8MM STEEL	MULTIBRAND

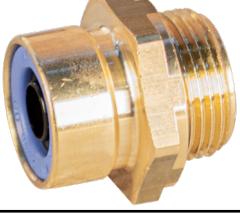
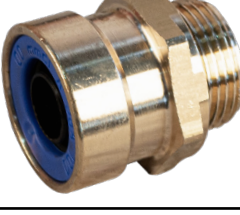
SAC NO.	IMAGE	DESCRIPTION	SUITABLE FOR I.E.
985930		T-TYPE CONNECTOR PUSH-IN 10MM STEEL	MULTIBRAND
SACFITL007		STRAIGHT CONNECTOR SCREW-IN 4MM BRASS	MULTIBRAND
SACFITL001		STRAIGHT CONNECTOR SCREW-IN 6MM BRASS	MULTIBRAND
SACFITL002		STRAIGHT CONNECTOR SCREW-IN 8MM BRASS	MULTIBRAND
SACFITL002A		STRAIGHT CONNECTOR SCREW-IN 9MM BRASS	MULTIBRAND
SACFITL003		STRAIGHT CONNECTOR SCREW-IN 10MM BRASS	MULTIBRAND
SACFITO001		T-PIECE PUSH IN CONNECTOR 12MM BRASS	MULTIBRAND
SACFITL004		STRAIGHT CONNECTOR SCREW-IN 12MM BRASS	MULTIBRAND

SAC NO.	IMAGE	DESCRIPTION	SUITABLE FOR I.E.
SACFITL004B		STRAIGHT CONNECTOR SCREW-IN 14MM BRASS	MULTIBRAND
SACFITL005		STRAIGHT CONNECTOR SCREW-IN 15MM BRASS	MULTIBRAND
SACFITL006		STRAIGHT CONNECTOR SCREW-IN 16MM BRASS	MULTIBRAND
SACBRAK16001		STRAIGHT JOINER 1/2 RUBBER HOSE	MULTIBRAND
SACBRAK16000		T-PIECE 1/2 RUBBER HOSE	MULTIBRAND
SACFITU003		UNION 1/4-12MM	MULTIBRAND
SACFITU001		UNION 1/2 - 12MM	MULTIBRAND
SACFITU002		UNION 3/8 - 12MM	MULTIBRAND

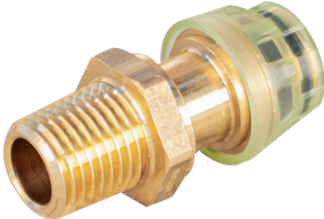
SAC NO.	IMAGE	DESCRIPTION	SUITABLE FOR I.E.
SACFITU004		UNION M22 X 12MM	MULTIBRAND
SACFITU005		UNION M16 X 12MM STEEL	MULTIBRAND
SACFITU005A		UNION M14 X 12MM	MULTIBRAND
SACFITU008A		UNION 1/8 - 12MM	MULTIBRAND
SACKNORR0001		RAUFOSS UNION M10 X 6MM	MULTIBRAND
SACKNORR0002		RAUFOSS UNION M12 X 6MM	MULTIBRAND
SACKNORR0004		RAUFOSS UNION M10 X 8MM	MULTIBRAND
SACKNORR0005		RAUFOSS UNION M12 X 8MM	MULTIBRAND

SAC NO.	IMAGE	DESCRIPTION	SUITABLE FOR I.E.
SACKNORR0006		RAUFOSS UNION M16 X 8MM	MULTIBRAND
SACKNORR0007		RAUFOSS UNION M22 X 8MM	MULTIBRAND
SACKNORR0008		RAUFOSS UNION M12 X 12MM	MULTIBRAND
SACKNORR0009		RUAFOSS UNION 16 X 12MM	MULTIBRAND
SACKNORR0010		RUAFOSS UNION M22 X 12MM	MULTIBRAND
SACKNORR0011		RUAFOSS UNION M22 X 15MM	MULTIBRAND
SACKNORR0003		RAUFOSS UNION M22 X 6MM	MULTIBRAND
SACKNORR0026		RAUFOSS ABC SWIVEL M12	MULTIBRAND

SAC NO.	IMAGE	DESCRIPTION	SUITABLE FOR I.E.
SACKNORR0027		RAUFOSS ABC SWIVEL M16	MULTIBRAND
SACKNORR0028		RAUFOSS ABC SWIVEL M22	MULTIBRAND
SACKNORR0029		RAUFOSS ABC SWIVEL 1/8	MULTIBRAND
SACKNORR0030		RAUFOSS ABC SWIVEL 1/4	MULTIBRAND
SACKNORR0031		RAUFOSS ABC SWIVEL 3/8	MULTIBRAND
SACKNORR0032		RAUFOSS ABC SWIVEL 1/2	MULTIBRAND
SACKNORR0033		RAUFOSS ABC SWIVEL FEMALE THREAD M16	MULTIBRAND
SACKNORR0034		RAUFOSS ABC SWIVEL FEMALE THREAD M22	MULTIBRAND

SAC NO.	IMAGE	DESCRIPTION	SUITABLE FOR I.E.
SACFITE003		AFTERMARKET AIR ELBOW BULKHEAD	BPW
SACFITE003A		AFTERMARKET AIR ELBOW SWIVEL	BPW
SACFITQ005		STRAIGHT CONNECTOR PUSH-IN 4MM PLASTIC	MULTIBRAND
SACFITQ001		STRAIGHT CONNECTOR PUSH-IN 6MM PLASTIC	MULTIBRAND
SACFITQ001B		STRAIGHT CONNECTOR PUSH-IN 1/4 PLASTIC	MULTIBRAND
SACFITQ002		STRAIGHT CONNECTOR PUSH-IN 8MM PLASTIC	MULTIBRAND
SACFITQ003		STRAIGHT CONNECTOR PUSH-IN 10MM PLASTIC	MULTIBRAND
SACFITQ004		STRAIGHT CONNECTOR PUSH-IN 12MM PLASTIC	MULTIBRAND

SAC NO.	IMAGE	DESCRIPTION	SUITABLE FOR I.E.
SACFITQ005A		STRAIGHT CONNECTOR PUSH-IN 14MM PLASTIC	MULTIBRAND
SACFITQ006		STRAIGHT CONNECTOR PUSH-IN 15MM PLASTIC	MULTIBRAND
SACFITQ006A		STRAIGHT CONNECTOR PUSH-IN 16MM PLASTIC	MULTIBRAND
018850446		STRAIGHT CONNECTOR PUSH-IN 4.5MM X 6MM	MULTIBRAND
SACFIQT005		T-PIECE CONNECTOR PUSH-IN 4MM PLASTIC	MULTIBRAND
SA1H0014		T-TYPECONNECTOR PUSH-IN 5MM PLASTIC	MULTIBRAND
SACFIQT001		T-PIECE CONNECTOR PUSH-IN 6MM PLASTIC	MULTIBRAND
SACFIQT002		T-PIECE CONNECTOR PUSH-IN 8MM PLASTIC	MULTIBRAND





SAC NO.	IMAGE	DESCRIPTION	SUITABLE FOR I.E.
SACFIQT003		T-PIECE CONNECTOR PUSH-IN 10MM PLASTIC	MULTIBRAND
SACFIQT004		T-PIECE CONNECTOR PUSH-IN 12MM PLASTIC	MULTIBRAND
K985835SA		90 DEG CONNECTOR PUSH-IN 4MM PLASTIC	MULTIBRAND
SA1H0007		ELBOW CONNECTOR PUSH-IN 4MM PLASTIC	MULTIBRAND
SA1H0009		ELBOW CONNECTOR PUSH-IN 6MM PLASTIC	MULTIBRAND
SA1H0010		ELBOW CONNECTOR PUSH-IN 8MM PLASTIC	MULTIBRAND
SA1H0011		ELBOW CONNECTOR PUSH-IN 10MM PLASTIC	MULTIBRAND
SA1H0012		ELBOW CONNECTOR PUSH-IN 12MM PLASTIC	MULTIBRAND

SAC NO.	IMAGE	DESCRIPTION	SUITABLE FOR I.E.
SACKNORR0012		RAUFOSS ABC PUSH IN COUPLING 8MM	MULTIBRAND
SACKNORR0013		RAUFOSS ABC PUSH IN COUPLING 10MM	MULTIBRAND
SACKNORR0014		RAUFOSS ABC PUSH IN COUPLING 12MM	MULTIBRAND
SACKNORR0045		RAUFOSS ABC THREADLESS TEST POINT	MULTIBRAND
SACKNORR0015		RAUFOSS ELBOW PUSH IN 6MM	MULTIBRAND
SACKNORR0016		RAUFOSS ELBOW PUSH IN 8MM	MULTIBRAND
SACKNORR0017		RAUFOSS ELBOW PUSH IN 12MM	MULTIBRAND
SACKNORR0018		RAUFOSS ELBOW PUSH-IN 15MM	MULTIBRAND

SAC NO.	IMAGE	DESCRIPTION	SUITABLE FOR I.E.
SACKNORR0019		RAUFOSS ABC TEE REGULAR FEMALE COUPLING	MULTIBRAND
SACKNORR0020		RAUFOSS ABC UNION TEE HEAVY DUTY	MULTIBRAND
SACKNORR0021		RAUFOSS ABC FEMALE COUPLINGS	MULTIBRAND
SACKNORR0022		RAUFOSS ABC Y UNION	MULTIBRAND
SACKNORR0023		RAUFOSS ABC 90 DEGREE ELBOW	MULTIBRAND
SACKNORR0024		RAUFOSS FEMALE COUPLING ABC 3 WAY BLOCK	MULTIBRAND
SACKNORR0025		RAUFOSS ABC 4 WAY CROSS CONNECTOR	MULTIBRAND
HOSES			
SACFIT0003		RUBBER HOSE 1/2	UNIVERSAL

SAC NO.	IMAGE	DESCRIPTION	SUITABLE FOR I.E.
SACNT-4		AIR PIPE NYLON 4MM	UNIVERSAL
SACNT-6		AIR PIPE NYLON 6MM BLACK	UNIVERSAL
SACNT-8		AIR PIPE NYLON 8MM BLACK	UNIVERSAL
SACNT-10		AIR PIPE NYLON 10MM BLACK	UNIVERSAL
SACNT-12		AIR PIPE NYLON 12MM BLACK	UNIVERSAL
986015		AIR PIPE NYLON 15MM	UNIVERSAL
SACNT-12R		AIR PIPE NYLON RED 12MM	UNIVERSAL
SACNT-12Y		AIR PIPE NYLON YELLOW 12MM	UNIVERSAL

SAC NO.	IMAGE	DESCRIPTION	SUITABLE FOR I.E.
S970036		AIR PIPE NYLON RED 12MM	UNIVERSAL
S970034		AIR PIPE NYLON YELLOW 12MM	UNIVERSAL
SACKNORR0035		RAUFOSS ROTOLOCK	MULTIBRAND
SACKNORR0036		RAUFOSS ROTOLOCK HEX X 22 X M16	MULTIBRAND
SACKNORR0037		RAUFOSS ROTOLOCK	MULTIBRAND
SACKNORR0038		RAUFOSS ROTOLOCK HEX X 28 X M16	MULTIBRAND
SACKNORR0039		RAUFOSS ROTOLOCK	MULTIBRAND
SACKNORR0040		RAUFOSS RELEASE TOOL PLASTIC 6MM	MULTIBRAND

SAC NO.	IMAGE	DESCRIPTION	SUITABLE FOR I.E.
SACKNORR0041		RAUFOSS RELEASE TOOL PLASTIC 8MM	MULTIBRAND
SACKNORR0042		RAUFOSS RELEASE TOOL PLASTIC 10MM	MULTIBRAND
SACKNORR0043		RAUFOSS RELEASE TOOL PLASTIC 12MM	MULTIBRAND
SACKNORR0044		RAUFOSS RELEASE TOOL PLASTIC 16MM	MULTIBRAND



ELECTRICAL



RELATED COMPONENTS

ELECTRIC SUZI (BLACK MAMBA)

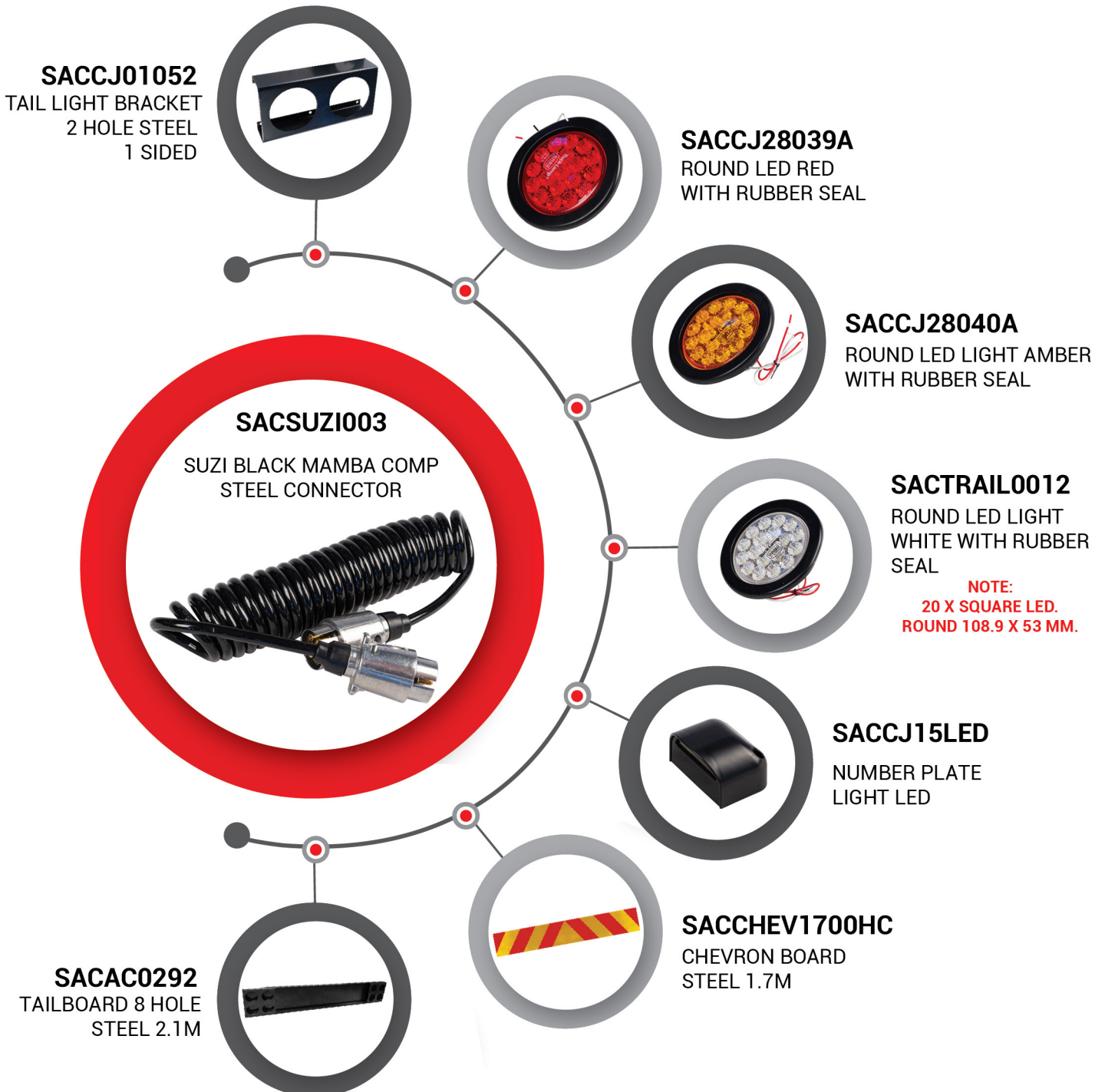

ELECTRICAL



SAC NO.	IMAGE	DESCRIPTION	SUITABLE FOR I.E.
SACSUZI006		SUZI ELECTRICAL COMPLETE 7PIN EBS/ABS BRAKING COIL	MULTIBRAND
SACSUZI003		SUZI ELECTRICAL BLACK MAMBA WITH PLUG	MULTIBRAND
SACLOC0001		SUZI BLACK MAMBA COMPLETE PLASTIC CONNECT 7 PIN	MULTIBRAND
SACSUZI005		SUZI ELECTRICAL CABLE ABS 15-7PIN 1.5 X 2.5MM	MULTIBRAND
SACSUZI005V		SUZI ELECTRICAL CABLE ABS 15-7PIN 1.5 X 2.5MM	MULTIBRAND
TRAILLINK0002		SUZI ELECTRICAL CABLE ABS 15-7 PIN	MULTIBRAND
SACMUL0023		SUZI ELECTRICAL ABS HYFLEX CABLE 15 TO 15 PIN	MULTIBRAND
TRAILLINK0003		SUZI ELECTRICAL WIRE ADAPTER 7PIN-7PIN	MULTIBRAND





ELECTRICAL



SAC NO.	IMAGE	DESCRIPTION	SUITABLE FOR I.E.
TRAILLINK0005		SUZI ELECTRICAL POLY-U WITH 2 X 15PIN PLUGS 7CORE PRIMAR	MULTIBRAND
S970017		SUZI ELECTRICAL POLY-U EURO MOULDED PLUGS BLACK	MULTIBRAND
TRAILLINK0001		SUZI ELECTRICAL BLACK MAMBA COMPLETE PLASTIC CONNECT 7PI	MULTIBRAND
TRAILLINK0004		SUZI ELECTRIC ABS HYFLEX CABLE 15 TO 15 PIN	MULTIBRAND
SACELEC008		ELECTRICAL CABLE 5 CORE	UNIVERSAL
SACSUZP001		SUZI ELECTRICAL MALE PLUG 15 PIN ABS	MULTIBRAND
SACSUZP002		SUZI ELECTRICAL FEMALE PLUG 15 PIN ABS	MULTIBRAND
SACTRAIL0003		ELECTRICAL FEMALE SOCKET EBS 7PIN	MULTIBRAND

ELECTRICAL



SAC NO.	IMAGE	DESCRIPTION	SUITABLE FOR I.E.
SACTQ28021		ELECTRICAL TRAILER CONNECTOR MALE 7PIN	MULTIBRAND
SACTQ28022		ELECTRICAL TRAILER CONNECTOR FEMALE 7PIN	MULTIBRAND
TRAILLINK0009		SUZI LOCK CATCH ASSEMBLY 700-102	MULTIBRAND
SACMUL0022		SUZI LOCK CATCH ASSEMBLY	MULTIBRAND
SACTRAIL502		ELECTRICAL EURO/US METAL SOCKET 7PIN	MULTIBRAND



ELECTRICAL



TRAILER WIRING - WIRE CIRCUIT

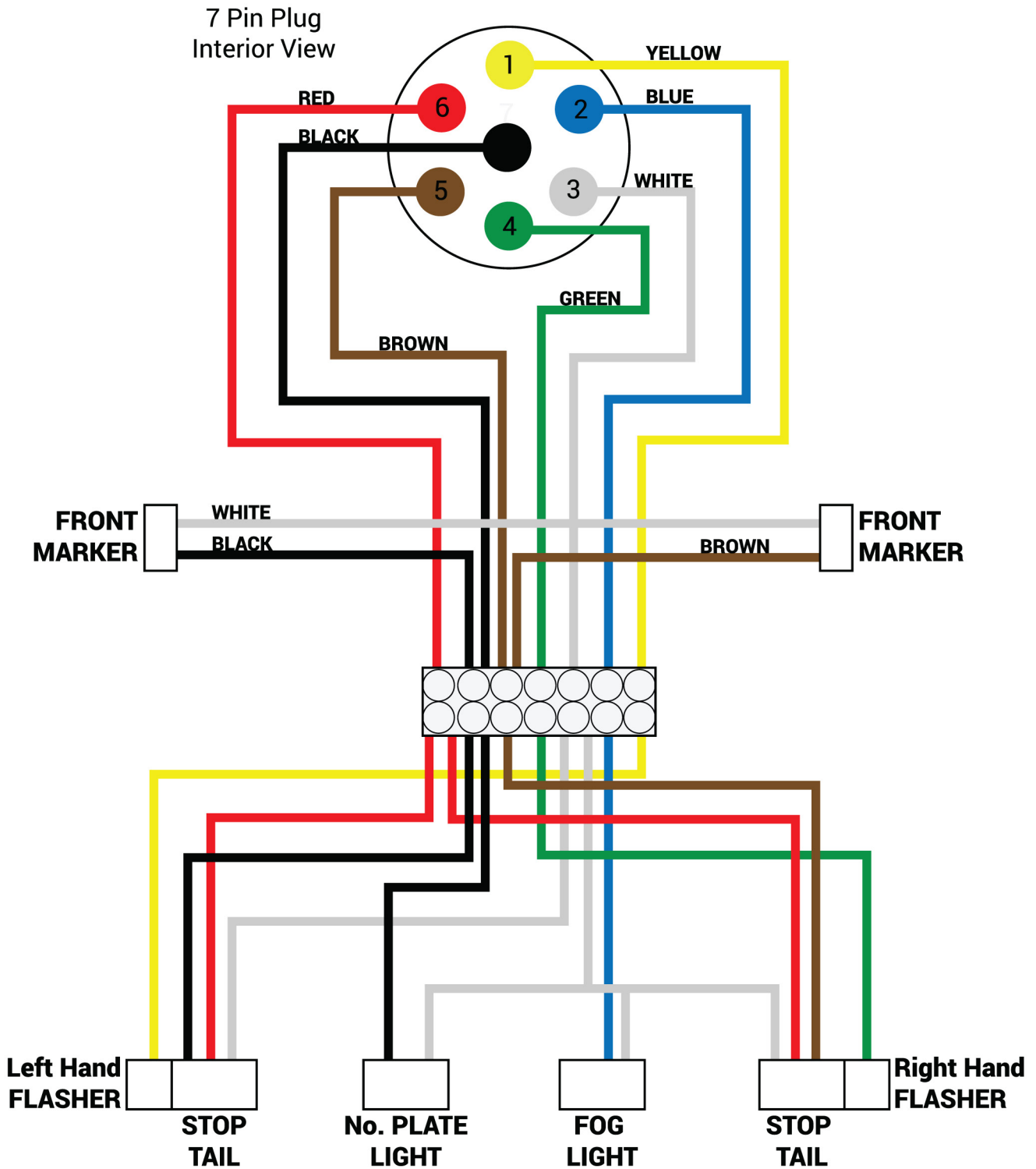

BODY



SAC NO.	IMAGE	DESCRIPTION	SUITABLE FOR I.E.
SACAC0289		TAILBOARD 4 HOLE STEEL 1.9M	MULTIBRAND
SACLIGH062		TAILBOARD 4 HOLE 2.1M	MULTIBRAND
SACLIGH304		TAILBOARD 8 HOLE PLASTIC 2.1M	MULTIBRAND
SACAC0292		TAILBOARD 8 HOLE STEEL 2.1M	MULTIBRAND
SACTQ30293		TAILBOARD 4 HOLE PLASTIC 2.4M	MULTIBRAND
SACAL21P		TAIL LIGHT BRACKET 3 HOLE STEEL	MULTIBRAND
SACCJ01052		TAIL LIGHT BRACKET 2 HOLE STEEL 1 SIDE	MULTIBRAND
SACCJ01058		TAIL LIGHT BRACKET 4 HOLE STEEL 1 SIDE	MULTIBRAND

SAC NO.	IMAGE	DESCRIPTION	SUITABLE FOR I.E.
S970014		THERMOPLASTIC LIGHT BOX 3 HOLE BLACK	MULTIBRAND
S970013		THERMOPLASTIC LIGHT BOX 2 HOLE BLACK	MULTIBRAND
S980008		WONDERLITE SILVER RING	MULTIBRAND
SACLIGH015		COMBO LIGHT BEZEL ROUND S/S	MULTIBRAND
SAC06-605		MUDGUARD MOUNTING BRACKET ADJUSTABLE	MULTIBRAND
SACMUDG002		MUDGUARD SUPER SINGLE LH/RH	MULTIBRAND
SACMUDG003		MUDGUARD DUAL DOUBLE WHEELS	MULTIBRAND
SACMUDG004		REAR TANDEM MUDGUARD STAINLESS STEEL	MULTIBRAND

SAC NO.	IMAGE	DESCRIPTION	SUITABLE FOR I.E.
SACMUDG005		FRONT TANDEM MUDGUARD STAINLESS STEEL	MULTIBRAND
SACTRAIL0020		MUDGUARD BOSS PIPE BRACKET COMPLETE	MULTIBRAND
SACBOSSP001		MUDGUARD BOSS PIPE	MULTIBRAND
SACTQ06600		BOSS PIPE BETA CLAMP	MULTIBRAND
S970005		MUDFLAP POLY PROP SAC BRANDED 600 X 900 X 5	MULTIBRAND
S970006		MUDFLAP POLY PROP PLAIN 600 X 900 X 5	MULTIBRAND
S970007		MUDFLAP POLY PROP PLAIN 600 X 400 X 5	MULTIBRAND
SACMUDF001		MUDFLAP X2 RUBBER 600 X 600	MULTIBRAND









SAC NO.	IMAGE	DESCRIPTION	SUITABLE FOR I.E.
SACMUDF002		MUDFLAP X2 POLY PROP PLAIN 600 X 600X 5	MULTIBRAND
SACJOSC012		PLASTIC PAD COMPLETE JAK 16/22	UNIVERSAL
SACJOSC013B		TOWING COUPLING ROCKINGER 40MM	MULTIBRAND
SACJOSC013A		TOWING COUPLING ROCKINGER 50MM	MULTIBRAND
SACAV2220		TOW HITCH THIN STEEL WASHER	UNIVERSAL
SACJOSC012B		OE JAK 22 HITCH RUBBER CUSHION	JOST
SACJOTE014		TOWING EYE WELD ON 40MM	MULTIBRAND
SACTQ30122		TOWING EYE WITH NUT 40MM	MULTIBRAND

SAC NO.	IMAGE	DESCRIPTION	SUITABLE FOR I.E.
SACZ04540MM		TOWING EYE BUSH 40MM	MULTIBRAND
S220006		OE WORM TENSIONER NO HANDLE	HENRED
S220007		OE WORM TENSIONER HANDLE ONLY	HENRED
SACT-BAR2T		TOWING BAR 2T L = 1.8M	MULTIBRAND
SACAV2222		TOW HITCH BRONZE SLEEVE	UNIVERSAL
SACAV2210		TOW HITCH CAP SCREW	UNIVERSAL



LIGHTS



SAC NO.	IMAGE	DESCRIPTION	SUITABLE FOR I.E.
SACCJ28039A		ROUND LED LIGHT RED WITH RUBBER SEAL	MULTIBRAND
SACCJ28040A		ROUND LED LIGHT AMBER WITH RUBBER SEAL	MULTIBRAND
SACTQ28039		ROUND LIGHT RED GLOBE TYPE WITH RUBBER SEAL	MULTIBRAND
SACTQ28040		ROUND LIGHT AMBER GLOBE TYPE WITH RUBBER SEAL	MULTIBRAND
SACTRAIL0012		ROUND LED LIGHT WHITE WITH RUBBER SEAL	MULTIBRAND
SACTL23LED		COMBO LED TAIL LIGHT WITH RUBBER SEAL	MULTIBRAND
SACTRAIL4060		RED STOP TAIL LENS 12 LED 110MM	MULTIBRAND
SACTRAIL4061		AMBER INDICATOR LENS 12 LED 110MM	MULTIBRAND

SAC NO.	IMAGE	DESCRIPTION	SUITABLE FOR I.E.
S980007		WONDERLITE AMBER INDICATOR 12/24	MULTIBRAND
S980006		WONDERLITE REAR STOP LIGHT 12/24	MULTIBRAND
SACTL23LEDF		TAIL LIGHT COMBO LED CHROME TRIM	MULTIBRAND
SACTRAILCL21		WONDERLITE COMBO 21LED 110MM CHROME BEZEL	MULTIBRAND
TL23LEDFC		COMBO TAIL LIGHT CLEAR LENS	MULTIBRAND
SACLEDMACA		MARKER LIGHT AMBER 6 X LED CHROME OVAL	MULTIBRAND
SACLEDMACR		MARKER LIGHT RED 6 X LED CHROME OVAL	MULTIBRAND
SACLEDMACW		MARKER LIGHT WHITE 6 X LED CHROME OVAL	MULTIBRAND

SAC NO.	IMAGE	DESCRIPTION	SUITABLE FOR I.E.
SACLEDMACG		MARKER LIGHT GREEN 6 LED CHROME OVAL	MULTIBRAND
SACMUL039		MARKER LIGHT CHROME RED LED	MULTIBRAND
SACMUL040		LIGHT MARKER CHROME WHITE LED	MULTIBRAND
SACLEDMLA		MARKER LIGHT ORANGE 10 X LED ROUND/RECTANGULAR	MULTIBRAND
SACLEDMLR		MARKER LIGHT RED 10 X LED ROUND/RECTANGULAR	MULTIBRAND
SACLEDMLG		MARKER LIGHT GREEN 10 X LED ROUND/RECTANGULAR	MULTIBRAND
SACMUL036		SIDE MARKER LIGHT ROUND GREEN LED	MULTIBRAND
SACMUL037		SIDE MARKER LIGHT ROUND RED LED	MULTIBRAND

LIGHTS



SAC NO.	IMAGE	DESCRIPTION	SUITABLE FOR I.E.
SACMUL038		SIDE MARKER LIGHT ROUND AMBER LED	MULTIBRAND
SACTQ28600		MARKER LIGHT RED LED RECTANGULAR	MULTIBRAND
SACMARKER-LH		SIDE MARKER LIGHT STALK L/H	MULTIBRAND
SACMARKER-RH		SIDE MARKER LIGHT STALK R/H	MULTIBRAND
S970030		REAR COMBINATION LIGHT LED R/H	MULTIBRAND
S970031		REAR COMBINATION LIGHT LED L/H	MULTIBRAND
S970016		LED COMBO LIGHT 10-30V WITH REVERSE LIGHT	MULTIBRAND
S970028		COMBINATION ROUND LIGHT LED RED & AMBER	MULTIBRAND

LIGHTS



SAC NO.	IMAGE	DESCRIPTION	SUITABLE FOR I.E.
S970029		COMBINATION ROUND LIGHT AMBER & AMBER LED	MULTIBRAND
S970026		WORK & DRIVING LIGHT H-POWER LED 24 X 3W	MULTIBRAND
SACTRAIL101		WARNING LIGHT LED CLEAR	MULTIBRAND
SACTRAIL102		WARNING LIGHT LED AMBER	MULTIBRAND
SACTRAILW001		WARNING LIGHT LED RED	MULTIBRAND
S970018		STROBE LIGHT THIN 6 LED GREEN	MULTIBRAND
S970019		STROBE LIGHT THIN 6 LED RED	MULTIBRAND
S970020		STROBE LIGHT THIN 6 LED AMBER	MULTIBRAND

LIGHTS



SAC NO.	IMAGE	DESCRIPTION	SUITABLE FOR I.E.
S970021		STROBE LIGHT THIN 6 LED CLEAR	MULTIBRAND
S970022		STROBE LIGHT THIN 4 LED RED	MULTIBRAND
S970024		STROBE LIGHT THIN 4 LED CLEAR	MULTIBRAND
S970025		STROBE LIGHT THIN 4 LED GREEN	MULTIBRAND
SACTRAIL4059		WONDERLITE LED NUMBER PLATE LIGHT	MULTIBRAND



WHEEL & HUB



RELATED COMPONENTS

HUB

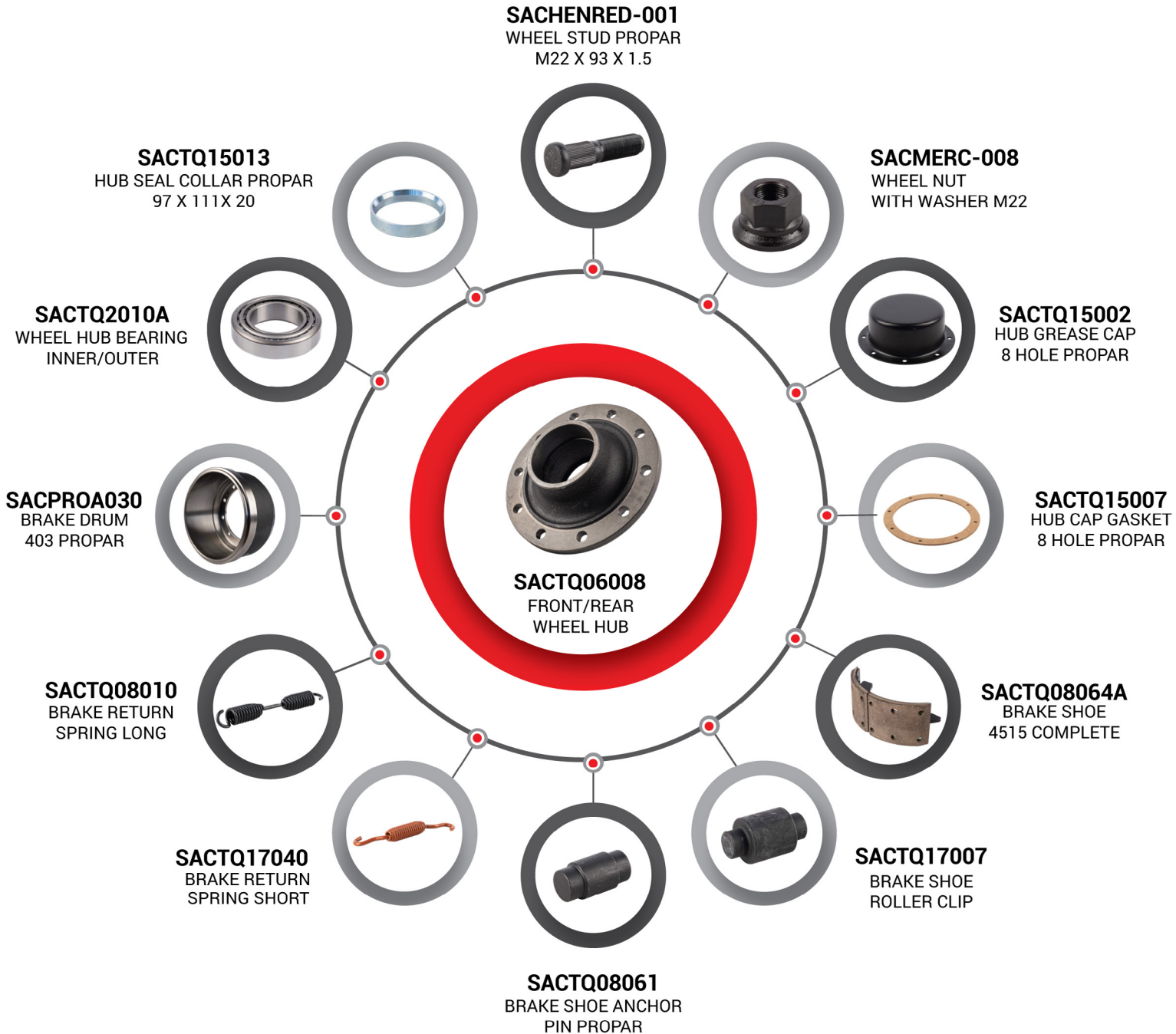

SACTRAIL4043

**AFTERMARKET
BRAKE SHOE
KIT 4515**

HENRED

WHEEL & HUB IDENTIFICATION



ECO Plus 9t

ECO Plus 2 9t

ECO Plus 10t

ECO Plus 3 9t

Front View:

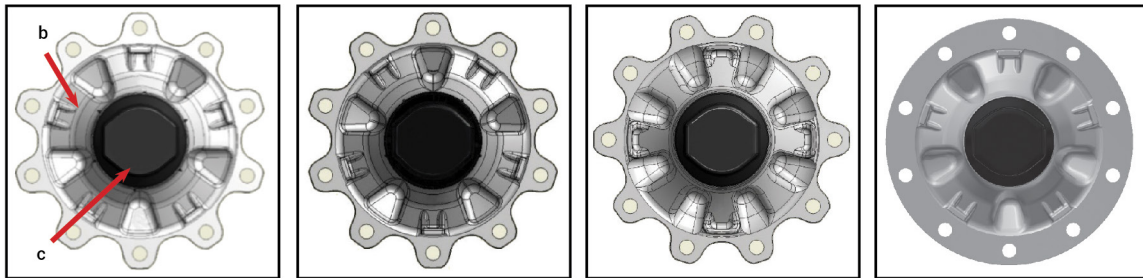

Isometric View:

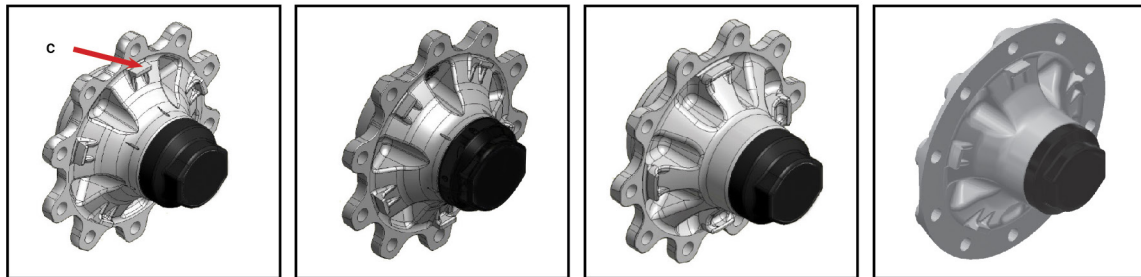

Side View

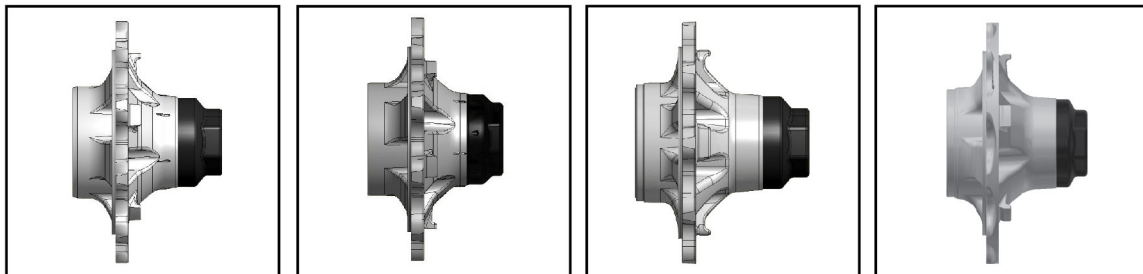

ID	ECO Plus 9t	ECO Plus 2 9t	ECO Plus 10t	ECO Plus 3 9t
a)	Casting Part number: 01.272.43.10.0	Casting Part number: 01.272.43.30.0	Casting Part number: 01.272.48.95.0	Casting Part number: 01.272.43.42.0
b)	Five wide spokes	Five wide spokes	Eight narrow spokes	Five wide spokes
c)	Five narrow spigots	Five narrow spigots	Four wide spigots	Four wide spigots
d)	"ECO Plus" written in a curve on the hub cap	"ECO Plus" written in a straight line on the hub cap	"ECO Plus" written in a curve on the hub cap	"ECO Plus" not written on the hub cap
e)	Screw-on hub cap Spanner Width = 110mm	Bayonet/Clip-on hub cap Spanner Width = 120mm	Screw-on hub cap Spanner Width = 110mm	Screw-on hub cap Spanner Width = 110mm
f)	Low height hub design h = 92 mm	Low height hub design h = 92 mm	Higher hub design h = 115.5 mm	Higher hub design h = 105mm
g)	ABS Ring – Bayonet style	ABS Ring – Bayonet style	ABS Ring – Press-on	ABS Ring – Press-on
h)	Hub part number: Single Wheels/Dual Steel Rim – 03.272.43.10.2	Hub part number: Single Wheels/Dual Steel Rim – 03.272.43.29.0 03.272.43.23.2	Hub part Number: All configurations – 03.272.43.23.2	Hub part Number: All configurations – 03.272.43.42.0
i)	Dual Wheel Aluminium Rims – 03.272.43.19.2 (Longer spigot) Hub assembly part number: Single Wheels/Dual Steel Rim – 09.801.06.07.0 Dual Wheel Aluminium Rims – 09.802.99.74.0	Dual Wheel Aluminium Rims – 03.272.43.30.0 (Longer spigot) Hub assembly part number: Single Wheels/Dual Steel Rim – 09.801.07.35.0 Dual Wheel Aluminium Rims – 09.801.07.44.0	Hub assembly part number: All configurations – 09.801.06.08.2	Hub assembly part number: All configurations – 09.801.08.39.0

WHEEL & HUB

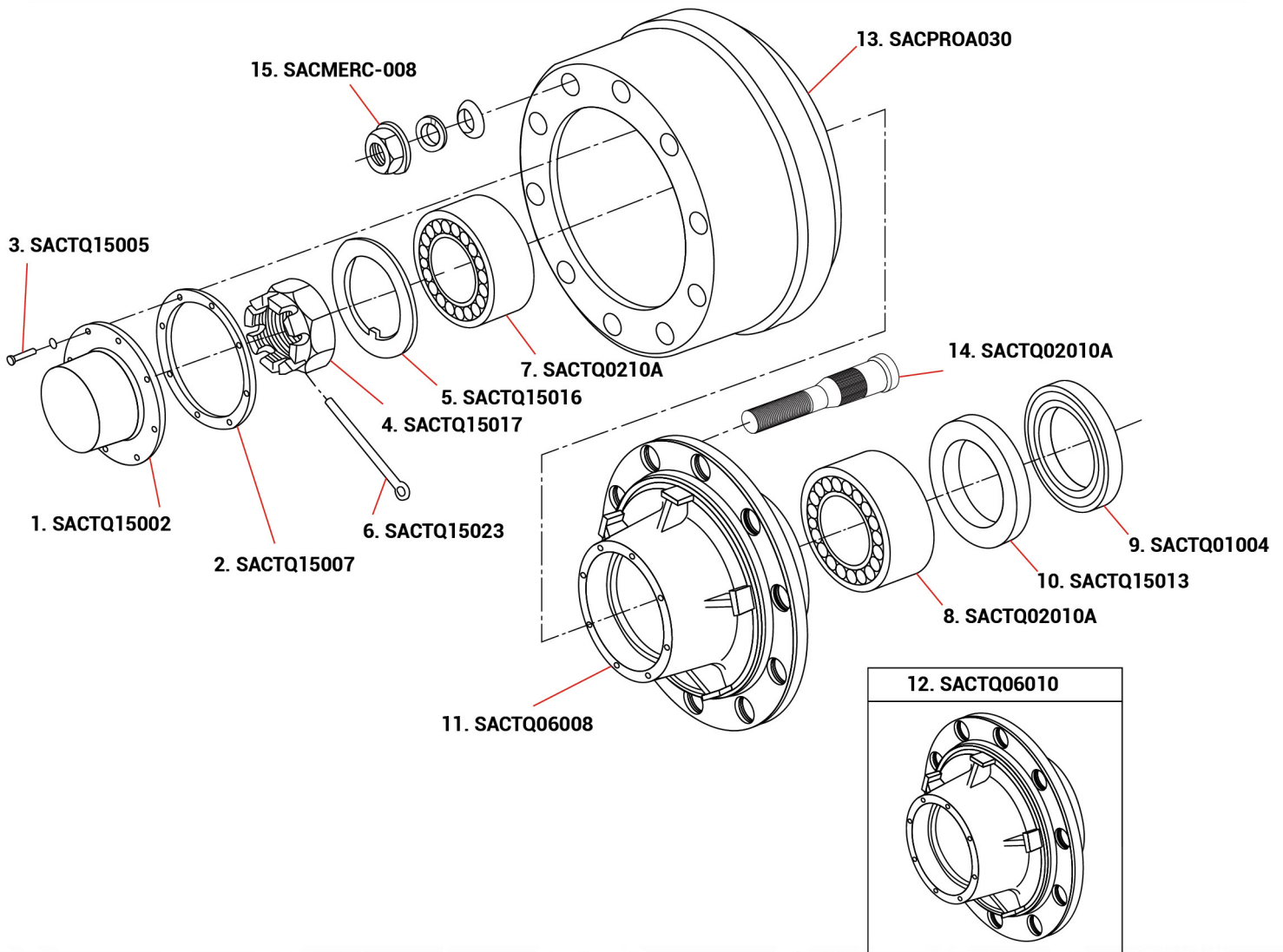

	Part Number	Description	Short Description
1	SACTQ15002	HENRED AFTERMARKET HUB GREASE CAP 8 HOLE PROPAP	Hubcap
2	SACTQ15007	HENRED AFTERMARKET HUB CAP GASKET 8 HOLE PROPAP	Gasket
3	SACTQ15005	HENRED AFTERMARKET HUB GREASE CAP SCREW M6 X16	Hubcap Bolt
4	SACTQ15017	HENRED AFTERMARKET HUB NUT PROPAP AXLE	Axle Nut
5	SACTQ15016	HENRED AFTERMARKET HUB NUT THRUST WASHER	Washer
6	SACTQ15023	HENRED AFTERMARKET HUB NUT SPLIT PIN 8X140MM	Split Pin
7	SACTQ0210A	HENRED AFTERMARKET WHEEL HUB BEARING INNER/OUTER	Bearings
8	SACTQ0210A	HENRED AFTERMARKET WHEEL HUB BEARING INNER/OUTER	Bearings
9	SACTQ01004	HENRED AFTERMARKET HUB SEAL PROPAP 111X152X12.7MM	Seal
10	SACTQ15013	HENRED OE HUB SEAL COLLAR PROPAP 97X111X20	Collar
11	SACTQ06008	HENRED AFTERMARKET FRONT/REAR WHEEL HUB	HUB Only
12	SACTQ06010	HENRED AFTERMARKET WHEEL HUB COMP PROPAP	Complete HUB
13	SACPROA030	HENRED AFTERMARKET BRAKE DRUM 403 PROPAP	Drum
14	SACHENRED-001	HENRED AFTERMARKET WHEEL STUD PROPAP M22X93X1.5	Stud
15	SACMERC-008	HENRED AFTERMARKET WHEEL NUT WITH WASHER M22	Nut









WHEEL & HUB



SAC NO.	IMAGE	DESCRIPTION	SUITABLE FOR I.E.
HUB			
SACTQ06012		AFTERMARKET WHEEL HUB U SERIES	SWIFT
SACTQ06013		AFTERMARKET WHEEL HUB INBOARD TM SERIES	SWIFT
SACTQ06014-1		AFTERMARKET WHEEL HUB TQ SERIES	SWIFT
SACTQ06017		AFTERMARKET WHEEL HUB OUTBOARD	SWIFT
SACBPW0121		OE WHEEL HUB COMPLETE ECO PLUS 3 9T	BPW
300.400		AFTERMARKET WHEEL HUB COMPLETE ECO PLUS 1	BPW
SACTQ06008		AFTERMARKET FRONT/REAR WHEEL HUB	HENRED
SACTQ06010		AFTERMARKET WHEEL HUB COMPLETE PROPAR	HENRED

WHEEL & HUB



SAC NO.	IMAGE	DESCRIPTION	SUITABLE FOR I.E.
SACTQ06007		OE WHEEL HUB INBOARD PROPAR	HENRED
SACTRAIL0038		OE WHEEL HUB COMPLETE ECO	BPW
SACTRAIL0039		AFTERMARKET WHEEL HUB COMPLETE ECO PLUS	BPW
SACTRAIL0064		AFTERMARKET WHEEL HUB COMPLETE ECO PLUS 2 9T	BPW
SACTQ06014		AFTERMARKET WHEEL HUB OUTBOARD TM SERIES	SWIFT
300.624		AFTERMARKET WHEEL HUB COMPLETE ECO PLUS 3 9T	BPW
S200008BOM		AFTERMARKET WHEEL HUB COMPLETE WITH NUT ECO PLUS 3 9T	BPW
SACTRAIL512		SAF OE FRONT/REAR WHEEL HUB FOR DRUM BRAKES	HOLLAND

WHEEL & HUB



SAC NO.	IMAGE	DESCRIPTION	SUITABLE FOR I.E.
SACTRAIL527		OE FRONT/REAR WHEEL HUB FOR DISC BRAKES	HOLLAND
SACBPWS098		OE HUB CAP SCREW TYPE ECO M135 X 2MM	BPW
SACBPWS098A		OE HUB CAP SCREW TYPE ECO PLUS M136 X 2.5MM	BPW
1010604		AFTERMARKET WHEEL HUB CAP ECO PLUS	BPW
300.219		AFTERMARKET HUB CAP SCREW TYPE M135 X 3MM	BPW
300.077		AFTERMARKET HUB CAP SCREW 125MM	BPW
300.079		OE HUB CAP SCREW TYPE ECO M135 X 2MM	BPW
SACMISC046A		OE HUB CAP SCREW TYPE M125 X 2MM	BPW

WHEEL & HUB



SAC NO.	IMAGE	DESCRIPTION	SUITABLE FOR I.E.
300.369		AFTERMARKET HUB CAP SCREW TYPE ECO PLUS M136 X 2MM	BPW
SACTQ15002		AFTERMARKET HUB GREASE CAP 8 HOLE PROPAR	HENRED
S220011		OE FR/REAR HUB CAP OIL FILLED	HENRED
SACPRUS002		AFTERMARKET HUB GREASE CAP 8 HOLE	PROTEA
SACTQ21004		AFTERMARKET WHEEL HUB CAP 6 HOLE	SWIFT
1399		AFTERMARKET HUB GREASE CAP	HENDRICKSON
400.131		AFTERMARKET HUB GREASE CAP 8 HOLE PROPAR	HENRED
SACTRAIL3105		AFTERMARKET HUB CAP STANDARD BASE	HENRED

WHEEL & HUB



SAC NO.	IMAGE	DESCRIPTION	SUITABLE FOR I.E.
SACTRAIL3106		AFTERMARKET HUB CAP INSERT H PRINTED	HENRED
SACTRAIL519		OE HUB CAP	HOLLAND
BEARINGS			
SACTRAIL0023		AFTERMARKET WHEEL HUB BEARING	HENDRICKSON
SACTQ02012A		AFTERMARKET WHEEL HUB BEARING	PROTEA
300.004		AFTERMARKET WHEEL HUB BEARING TAPERED	BPW
SACTQ02005		AFTERMARKET WHEEL HUB BEARING BIG	BPW
SACTQ02006		AFTERMARKET WHEEL HUB BEARING TAPERED	BPW
SACTQ02003		AFTERMARKET WHEEL HUB BEARING SMALL	BPW

WHEEL & HUB



SAC NO.	IMAGE	DESCRIPTION	SUITABLE FOR I.E.
SACTQ02010A		AFTERMARKET WHEEL HUB BEARING INNER/OUTER	HENRED
300.014		AFTERMARKET WHEEL HUB BEARING BIG	BPW
SACTQ02009		AFTERMARKET FRONT/REAR WHEEL HUB BEARING	HENRED
SACTQ02002		AFTERMARKET WHEEL HUB BEARING BIG	BPW
SACTQ02010		AFTERMARKET FRONT/REAR WHEEL HUB BEARING	HENRED
SACTQ02015		AFTERMARKET FRONT/RAER WHEEL HUB BEARING	HENRED
SACTRAIL521		OE WHEEL BEARING REPAIR KIT 88MM	HOLLAND
SACTRAIL515		OE ROLLER BEARING REPAIR KIT 88MM	HOLLAND

WHEEL & HUB



SAC NO.	IMAGE	DESCRIPTION	SUITABLE FOR I.E.
SACTQ01003		AFTERMARKET HUB SEAL H2 BOGIE 101 X 127 X 12.7MM	SWIFT
SACTQ01004		AFTERMARKET HUB SEAL PROPAR 111 X 152 X 12.7MM	HENRED
SACBPWS055C		OE HUB DUST SEAL 133 X 160 X 15MM	BPW
SACOILS004		AFTERMARKET HUB SEAL 158 X 184 X 12.7MM	SWIFT
SACTQ01006		AFTERMARKET HUB SEAL 114 X 155 X 12.7MM	SWIFT
300.011		AFTERMARKET HUB GREASE SHIELD SEAL 84 X 129 X 8.5MM	BPW
330.002NA		AFTERMARKET HUB SEAL 120 X 160 X 25.4MM	ROCKWELL
300.134		AFTERMARKET HUB SEAL FLAT 110 X 141 X 2.5MM	BPW

WHEEL & HUB



SAC NO.	IMAGE	DESCRIPTION	SUITABLE FOR I.E.
300.168		AFTERMARKET HUB DUST SEAL	BPW
GR310		AFTERMARKET HUB DUST SEAL	BPW
GR311		AFTERMARKET HUB DUST SEAL 133 X 160 X 15MM	BPW
GR131		AFTERMARKET HUB SEAL 135 X 157 X 8MM	BPW
GR113		AFTERMARKET HUB SEAL 160 SERIES	YORK
SACTQ01007		AFTERMARKET HUB SEAL 120 X 150 X 12.7MM	BPW
SACTQ01009		AFTERMARKET HUB SEAL 256 X 167 X 13MM	BPW
SACTQ01018		AFTERMARKET HUB SEAL U SERIES 139 X 146 X 19.7MM	PROTEA

WHEEL & HUB



SAC NO.	IMAGE	DESCRIPTION	SUITABLE FOR I.E.
SACTQ01119		AFTERMARKET HUB SEAL NEW GEN 107.95 X 152.4 X 25MM	HENRED
SACTQ01017		AFTERMARKET HUB SEAL GREEN GO AXLE	HENRED
GR300		AFTERMARKET HUB SEAL 125 X 160MM	YORK
SACOILS006A		OE HUB SEAL 135 X 157 X 8MM	BPW
SACOILS013		AFTERMARKET HUB SEAL 120 X 152 X 19.7MM	PROTEA
SACOILS029		AFTERMARKET HUB SEAL 125 X 160MM	YORK
SACPRTM012		AFTERMARKET HUB SEAL COLLAR	ROCKWELL
SACOILS010C		AFTERMARKET HUB SEAL 120 X 160 X 25.4MM	ROCKWELL

WHEEL & HUB



SAC NO.	IMAGE	DESCRIPTION	SUITABLE FOR I.E.
SACOILS031A		OE HUB SEAL FLAT 110 X 141 X 2.5MM	BPW
SACTQ15013		OE OIL SEAL COLLAR PROPAR 97 X 111 X 20MM	HENRED
SACTRAIL511		SAF OE WHEEL HUB BEARING SEAL REPAIR KIT	HOLLAND
SACTRAIL0035		OE HUB SEAL ECO PLUS 117.5 X 158 X 17.5	BPW
GR314		AFTERMARKET HUB SEAL ECO PLUS 117.5 X 158 X 17.6	BPW
SA7Y0004		AFTERMARKET HUB SEAL ECO PLUS 117.5 X 158 X 17.5MM	BPW
SACPRUS007		AFTERMARKET HUB CAP GASKET 8 HOLE	PROTEA
SACTQ15007		AFTERMARKET HUB CAP GASKET 8 HOLE PROPAR	HENRED

WHEEL & HUB



SAC NO.	IMAGE	DESCRIPTION	SUITABLE FOR I.E.
SACSWIF029		AFTERMARKET HUB CAP GASKET 6 HOLE	SWIFT
S200009		OE WHEEL HUB SHAFT SEAL ECO PLUS 3	BPW
SACBPWS055CA		OE HUB DUST SEAL	BPW
1010461		AFTERMARKET HUB THRUST COLLAR	BPW
300.171		AFTERMARKET HUB THRUST COLLAR	BPW
300.633		AFTERMARKET HUB THRUST COLLAR	BPW
SACBPWH029B		OE HUB THRUST COLLAR 145 X 99.9 X 36MM	BPW
SACBPWS028B		OE HUB THRUST COLLAR	BPW

WHEEL & HUB



SAC NO.	IMAGE	DESCRIPTION	SUITABLE FOR I.E.
SACTQ21027		AFTERMARKET HUB SEAL COLLAR LARGE 101 X 158 X 19.5MM	SWIFT
300.305		AFTERMARKET WHEEL ABS RING 125 X 165 X 8.5MM	BPW
SACBPWS055CB		OE WHEEL ABS RING 125 X 165 X 8.5MM	BPW
300.006		AFTERMARKET HUB BEARING THRUST WASHER	BPW
SACBPWS096A		OE HUB BEARING THRUST WASHER	BPW
SACBPW0009		AFTERMARKET THRUST WASHER KIT	BPW
SACBPWS030		OE HUB NUT THRUST WASHER	BPW
SACTQ15016		AFTERMARKET HUB NUT THRUST WASHER	HENRED

WHEEL & HUB



SAC NO.	IMAGE	DESCRIPTION	SUITABLE FOR I.E.
LW115		AFTERMARKET HUB BEARING THRUST WASHER	BPW
SACBPWS095A		OE HUB DUST SEAL 94 X 149 X 8.5MM	BPW
300.016		AFTERMARKET HUB RING DIA 151/161 X 12.5MM	BPW
SACBPWS034		OE HUB RING DIA 151/161 X 12.5MM	BPW
300.359		AFTERMARKET HUB BEARING CIRCLIP 122 X 4MM	BPW
SACBPWS084A		OE HUB BEARING CIRCLIP 160 X 4MM	BPW
SACTQ30223		AFTERMARKET HUB ODOMETER STEMCO	BPW
STUDS & NUTS			
SACBPWS028AB		OE HUB NUT & WASHER ECO PLUS 2	BPW

WHEEL & HUB



SAC NO.	IMAGE	DESCRIPTION	SUITABLE FOR I.E.
300.413		AFTERMARKET HUB NUT & WASHER ECO PLUS 2	BPW
SACBPWS028A		OE HUB NUT & WASHER KIT ECO PLUS	BPW
SACTRAIL513		SAF OE AXLE NUT L/H WITH GROOVE M75 X 1.5 SW85	HOLLAND
SACTRAIL514		SAF OE AXLE NUT R/H NO GROOVE M75 X 1.5 SW85	HOLLAND
SACTQ19001		AFTERMARKET HUB NUT M65 X 1.5MM	ROCKWELL
SACTQ17013		AFTERMARKET HUB NUT 2 5/8 INCH	HENRED
SACTRAIL0036		OE HUB NUT LOCK WEDGE	BPW
SACTRAIL0037		OE HUB NUT LOCK RING 62 X 1.8MM	BPW

WHEEL & HUB



SAC NO.	IMAGE	DESCRIPTION	SUITABLE FOR I.E.
SACBPWS032		OE HUB NUT LOCK PIN	BPW
300.169		AFTERMARKET HUB NUT LOCK PIN	BPW
300.360		AFTERMARKET AXLE CIRCLIP	BPW
SACTQ15023		AFTERMARKET HUB NUT SPLIT PIN 8 X 140MM	HENRED
SACTRAIL0063		AFTERMARKET HUB NUT SPLIT PIN 8 X 140 MM	HENRED
SACHENRED-004		AFTERMARKET WHEEL STUD BACK WASHER PROPAR	HENRED
SACHENRED-005		AFTERMARKET WHEEL NUT WASHER PROPAR 22MM	HENRED
SACTQ15015		AFTERMARKET HUB NUT 10MT M60 X 4MM	HENRED

WHEEL & HUB



SAC NO.	IMAGE	DESCRIPTION	SUITABLE FOR I.E.
300.373		AFTERMARKET WHEEL HUB NUT ECO PLUS 3 9T M52 X 2P	BPW
SACTQ15017		AFTERMARKET HUB NUT PROPAR AXLE	HENRED
SACBPWS031		OE HUB NUT ECO / ECO MAXX	BPW
300.001		AFTERMARKET HUB NUT ECO / ECO MAXX	BPW
300.133		AFTERMARKET HUB NUT CASTLE SW80 M52 X 2MM	BPW
SACBPWH006D		OE HUB NUT CASTLE SW65 M42 X 2MM	BPW
300.185		AFTERMARKET HUB NUT CASTLE SW65 M42 X 2MM	BPW
SACTQ15014		AFTERMARKET HUB NUT IMPERIAL	SWIFT

WHEEL & HUB



SAC NO.	IMAGE	DESCRIPTION	SUITABLE FOR I.E.
600.072		AFTERMARKET WHEEL NUT WITH WASHER M22	MULTIBRAND
SACMERC-008		AFTERMARKET WHEEL NUT WITH WASHER M22	HENRED
SACHENRED019		AFTERMARKET WHEEL STUD BACK NUT	SWIFT
SACHENRED-003		AFTERMARKET WHEEL NUT PROPAP M22 X 1.5	HENRED
SACHENRED011		AFTERMARKET WHEEL NUT R/H 3/4 BSF	SWIFT
SACPROTEA005		AFTERMARKET WHEEL NUT M22 X 2MM	PROTEA
SACHENRED015		AFTERMARKET WHEEL NUT OUTER 7/8 BSF TAPERED	HENRED
SACHENRED010		AFTERMARKET WHEEL NUT R/H 7/8 BSF TAPERED	HENRED

WHEEL & HUB



SAC NO.	IMAGE	DESCRIPTION	SUITABLE FOR I.E.
SACHENRED012		AFTERMARKET WHEEL STUD BACK NUT	SWIFT
SACHENRED009		OE WHEEL STUD BACK NUT M22 X 2.5MM	HENRED
SACROCKWELL-003		AFTERMARKET WHEEL STUD BACK NUT 7/8 BSF	SWIFT
1010044		AFTERMARKET WHEEL STUD KIT ECO M22 X 1.5 X 114MM	BPW
SACBPW-001		OE WHEEL STUD KIT ECO M22 X 1.5 X 112	BPW
300.395		AFTERMARKET WHEEL STUD KIT ECO M22X1.5X112MM	BPW
SACHENRED007		AFTERMARKET WHEEL STUD R/H 10MT	HENRED
SACHENRED008		AFTERMARKET WHEEL STUD L/H 10MT	HENRED

WHEEL & HUB



SAC NO.	IMAGE	DESCRIPTION	SUITABLE FOR I.E.
SACHENRED016		AFTERMARKET WHEEL STUD DUAL L/H 7/8 BSF M20 X 1.5	HENRED
SACSWIF-001		AFTERMARKET HUB STUD R/H	SWIFT
SACSWIF-003		AFTERMARKET WHEEL STUD DUAL R/H 7/8 BSF X 7/8	SWIFT
SACSWIF-004		AFTERMARKET WHEEL STUD DUAL L/H 7/8 BSF X 7/8	SWIFT
SACSWIF-005		AFTERMARKET WHEEL STUD DUAL L/H 7/8 BSF X 7/8	SWIFT
SACSWIF-006		AFTERMARKET WHEEL STUD DUAL R/H 7/8 BSF X 7/8	SWIFT
SACSWIF-007		AFTERMARKET WHEEL STUD DUAL L/H 7/8 BSF X 3/4	SWIFT
SACSWIF-008		AFTERMARKET WHEEL STUD DUAL R/H 7/8 BSF X 3/4	SWIFT

WHEEL & HUB



SAC NO.	IMAGE	DESCRIPTION	SUITABLE FOR I.E.
SACHENRED017		AFTERMARKET WHEEL STUD R/H	HENRED
SACROCKWELL-001		AFTERMARKET WHEEL STUD DUAL R/H 7/8 BSF X 7/8	ROCKWELL
SACROCKWELL-002		AFTERMARKET WHEEL STUD L/H 7/8 BSF X L107	ROCKWELL
SACPROTEA003		AFTERMARKET WHEEL STUD M22 X 1.5 X L96.5MM	PROTEA
SACPROTEA004		AFTERMARKET WHEEL STUD M22 X 1.5 X L106MM	PROTEA
SACBPW-002		AFTERMARKET WHEEL STUD ECO PLUS M22 X 1.5 X 97MM	BPW
SACBPW-003		AFTERMARKET WHEEL STUD ECO PLUS ALU M22 X 1.5 X 117	BPW
SACBPW-003CJ		AFTERMARKET WHEEL STUD ECO PLUS ALU M22 X 1.5 X 117	BPW

WHEEL & HUB



SAC NO.	IMAGE	DESCRIPTION	SUITABLE FOR I.E.
SACPROTEA001		AFTERMARKET WHEEL STUD R/H 7/8 BSF X L93	PROTEA
SACHENRED-001		AFTERMARKET WHEEL STUD PROPAR M22 X 93 X 1.5	HENRED
SACHENRED002		AFTERMARKET WHEEL STUD PROPAR M22 X 120 X 1.5	HENRED
SACHENRED006		AFTERMARKET WHEEL STUD M22 X 2 X 102	HENRED/YORK
SACTQ15005		AFTERMARKET HUB GREASE CAP SCREW M6 X 16	HENRED



SUSPENSION



RELATED COMPONENTS

ROCKER BOX

SACTQ10015C
ROCKER BOX
BUSH CLEAR



SACTQ18012
ROCKER BOX PIN
50.8X285MM



SACTQ10034
WEAR PLATE HEX
BOLT M16 X 150



AFTERMARKET

FRONT ROCKER
EQUALISER F3



SACTQ03023
WEAR PLATE
NYLOC NUT



SACTQ10034A
WEAR PLATE
SPACER TUBE



SACTQ10051
HANGER BRACKET
CENTRE SHORT



SACTQ10014
LEAF SPRING
WEAR PLATE



SUSPENSION



RELATED COMPONENTS

RADIUS ROD

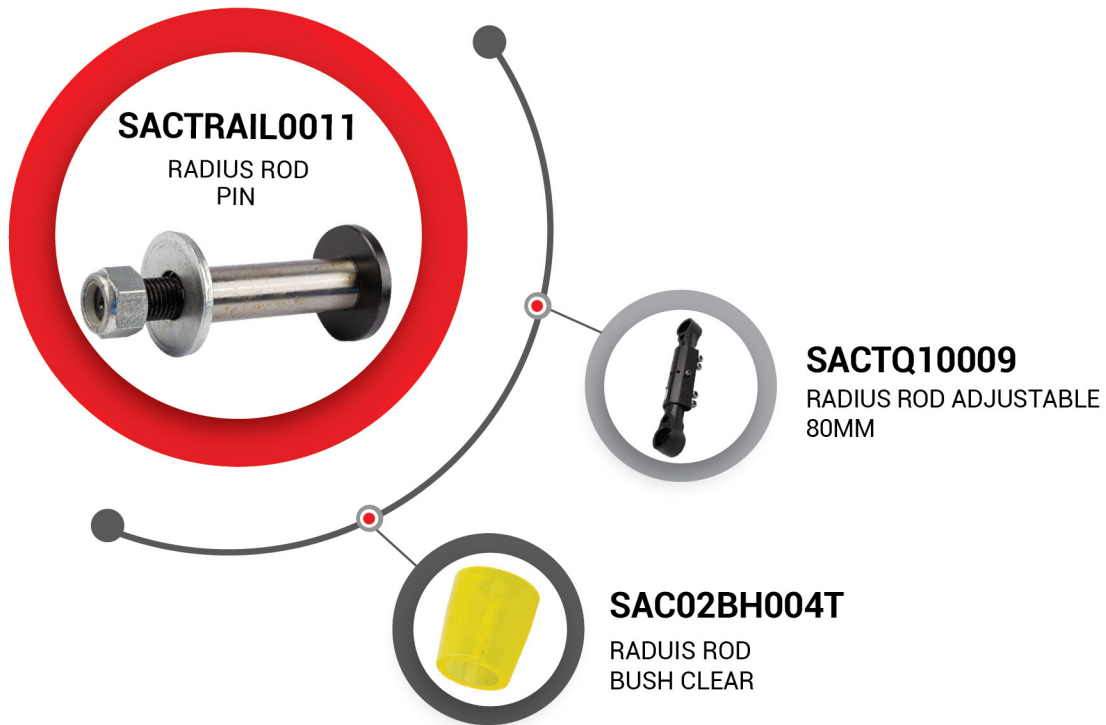

SPIDER BRACKET



SUSPENSION



RELATED COMPONENTS

LEAF SPRING

SACTQ27001

LEAF SPRING CENTRE BOLT
M14 X 145 W/NUT

NOTE:

BOLT AND NUT. M14 X 145 MM

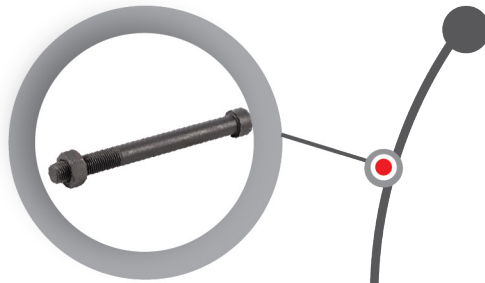

SACTQ10032
LEAF SPRING
PACK 9 BLADE

SACTQ10027

U-BOLT 9 BLADE
M22 X 2.5 X 370 X 80

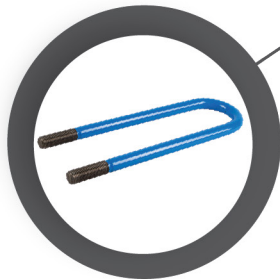

SACTQ10007

LEAF SPRING U-BOLT
8BLADE

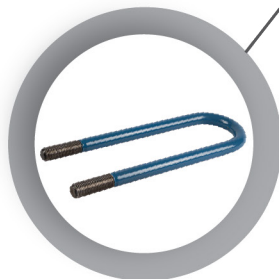

SACTQ10005

U-BOLT STRONG BACK
80MM

SUSPENSION IDENTIFICATION

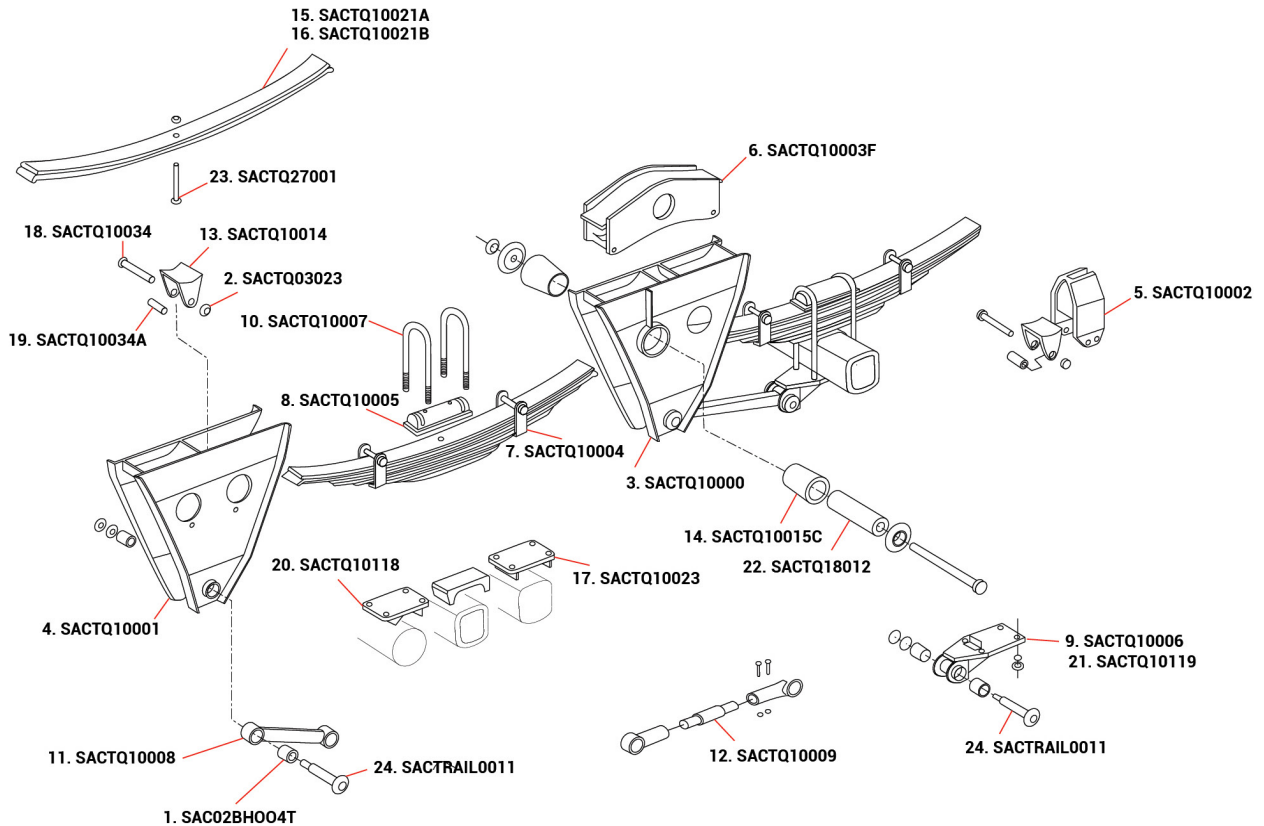

Part Number	Description	Short Description	
1	SAC02BH004T	HENRED AFTERMARKET RADIUS ROD BUSH CLEAR	Bush
2	SACTQ03023	- UNIVERSAL NYLOC NUT M16	Mig Nut
3	SACTQ10000	HENRED AFTERMARKET HANGER BRACKET F SERIES	Rocker
4	SACTQ10001	HENRED AFTERMARKET HANGER BRACKET FRONT TAPER	Front Hanger
5	SACTQ10002	HENRED AFTERMARKET HANGER BRACKET REAR F SERIES	Rear Suspencion
6	SACTQ10003F	HENRED AFTERMARKET ROCKER BOX	Rocker Box
7	SACTQ10004	HENRED AFTERMARKET LEAF SPRING PACK 8 BLADE	8-Blade Spring
8	SACTQ10005	HENRED AFTERMARKET U-BOLT STRONG BACK 80MM	Strong Back X2
9	SACTQ10006	HENRED AFTERMARKET FRONT AXLE SEAT SQ F SERIES	Axle Seal
10	SACTQ10007	HENRED AFTERMARKET LEAF SPRING UBOLT 8BLADE M22X2X	U-Bolt
11	SACTQ10008	HENRED AFTERMARKET RADIUS ROD FIXED F3 420MM SHORT	Fixed Radius Rod
12	SACTQ10009	HENRED AFTERMARKET RADIUS ROD ADJUSTABLE 420MM	Adj Radius Rod
13	SACTQ10014	HENRED AFTERMARKET LEAF SPRING WEAR PLATE	Complete
14	SACTQ10015C	HENRED AFTERMARKET ROCKER BOX BUSH CLEAR	Rocker Bush
15	SACTQ10021A	HENRED AFTERMARKET LEAF SPRING MAIN BLADE STRAIGHT	Mainblade Straight
16	SACTQ10021B	HENRED AFTERMARKET LEAF SPRING MAIN BLADE BENT	Mainblade Bent
17	SACTQ10023	HENRED AFTERMARKET LEAF SPRING/AXLE CLAMP PLATE 16	Clamp Plate
18	SACTQ10034	HENRED AFTERMARKET WEAR PLATE HEX BOLT M16X150	Bolt M16X150
19	SACTQ10034A	HENRED AFTERMARKET WEAR PLATE SPACER TUBE	Spacer Tube
20	SACTQ10118	HENRED AFTERMARKET LEAF SPRING/AXLE CLAMP PLATE RO	Clamp Plate Round
21	SACTQ10119	HENRED AFTERMARKET AXLE SEAT ROUND	Axle Seat Round
22	SACTQ18012	HENRED AFTERMARKET ROCKER BOX PIN 50.8X284MM	Rocker Pin
23	SACTQ27001	HENRED AFTERMARKET LEAF SPRING CENTRE BOLT M14X145 W	Center Bolt
24	SACTRAILO011	HENRED AFTERMARKET RADIUS ROD PIN	Rodius Rod Pin

SUSPENSION



SAC NO.	IMAGE	DESCRIPTION	SUITABLE FOR I.E.
LEAF SPRING			
SACTQ24019		AFTERMARKET TRAILING ARM SHORT BEND 100 X 500MM	BPW
SACBPWAI004D		OE TRAILING ARM SINGLE 70MM	BPW
SACTRAILEE75		AFTERMARKET Z - SPRING BLADE	HENRED / WEWELER
SACTRAIL10301		AFTERMARKET Z - SPRING 146 ROUND 2-HOLE	HENRED / WEWELER
SACTQ24014		AFTERMARKET TRAILING ARM LONG BEND	BPW
SACHENDRIKSON01		AFTERMARKET TRAILING ARM STRAIGHT	HENDRICKSON
SACTRAIL0069		AFTERMARKET TRAILING ARM	AFRIT
SACTQ10021B		AFTERMARKET LEAF SPRING MAIN BLADE BENT	HENRED

SUSPENSION



SAC NO.	IMAGE	DESCRIPTION	SUITABLE FOR I.E.
SACTQ10021A		AFTERMARKET LEAF SPRING MAIN BLADE STRAIGHT	HENDRED
SACHEN00003		AFTERMARKET LEAF SPRING MAIN BLADE STRAIGHT	HENRED
SACTRAIL4052		AFTERMARKET LEAF SPRING PACK 3 BLADE	HENRED
SACTQ10500		AFTERMARKET LEAF SPRING PACK 3 BLADE	HENRED
SACTRAIL0015		AFTERMARKET LEAF SPRING PACK 3 BLADE 10TON	BPW
SACTRAIL30221		AFTERMARKET LEAF SPRING PACK 3 BLADE 10TON	BPW
S220012		OE LEAF SPRING PACK 7 BLADE	HENRED
SACHEN00001		AFTERMARKET LEAF SPRING PACK 8 BLADE	HENRED

SUSPENSION



SAC NO.	IMAGE	DESCRIPTION	SUITABLE FOR I.E.
SACTQ10004		AFTERMARKET LEAF SPRING PACK 8 BLADE	HENRED
SACTQ10032		AFTERMARKET LEAF SPRING PACK 9 BLADE	HENRED
SACHEN00002		AFTERMARKET LEAF SPRING PACK 9 BLADE	HENRED
SACTRAIL3020		OE LEAF SPRING VB - 10T/13 BLADE	BPW
SACBPWAIR002A		OE TRAILING ARM SAFETY CATCH 60MM	BPW
SACBPWAIR001		OE TRAILING ARM SAFETY CATCH 90MM	BPW
AXLE			
SACTRAIL1023		OE LIFTING AXLE KIT M24	BPW
SACTRAIL1940		AFTERMARKET 1940 SQUARE 120 NON ABS AXLE	BPW

SUSPENSION



SAC NO.	IMAGE	DESCRIPTION	SUITABLE FOR I.E.
SACTRAIL127R		AFTERMARKET 127 ROUND 1910 AXLE COMP NON ABS	HENRED
SACTRAILAB004		AFTERMARKET AXLE BEAM 127 ROUND 1910	HENRED
SACTQ09000		AFTERMARKET CROSS SHAFT LONG 101 X 1248MM	HENRED
SACTQ08002		AFTERMARKET BRAKE SPIDER BRACKET	HENRED
SACTQ27155		AFTERMARKET SPIDER BRACKET	SAMTOR
SACTQ15010		AFTERMARKET TORQUE BRACKET FLANGE	HENRED
SACTRAIL16102		AFTERMARKET AXLE SEAT WEW 146HR R/H	HENRED / WEWELER
SACTRAIL16101		AFTERMARKET AXLE SEAT WEW 146 HR L/H	WEWELER

SUSPENSION



SAC NO.	IMAGE	DESCRIPTION	SUITABLE FOR I.E.
SACTQ10119		AFTERMARKET AXLE SEAT ROUND	HENRED
SACTQ10006		AFTERMARKET FRONT AXLE SEAT SQ F SERIES	HENRED
SACTQ10402		AFTERMARKET AXLE SEAT	WEWELER
SACTQ10400		AFTERMARKET AXLE SEAT ROUND L/H	HENRED
SACTQ10401		AFTERMARKET AXLE SEAT ROUND R/H	HENRED
SACBPWAS0306F		OE Z-SPRING SPRING PAD L/H	BPW
SACBPWAS0306FA		OE Z-SPRING SPRING PAD R/H WITH OUT SHOCK STUD	BPW
SACBPWAS0303		OE Z-SPRING SPRING PAD R/H	BPW

SUSPENSION



SAC NO.	IMAGE	DESCRIPTION	SUITABLE FOR I.E.
SACBPWAS0306EA		OE Z-SPRING SPRING PAD WITH SHOCK STUD R/H	BPW
SACBPWAS0306AB		OE Z-SPRING SPRING PAD WITH SHOCK STUD L/H	BPW
SACBPWAS0306A		OE Z-SPRING SPRING PAD WITH SHOCK BOLT L/H	BPW
SACBPWAS0306AA		OE SPRING PAD WITH SHOCK BOLT R/H	BPW
SACBPWAS1035		OE GUSSET PLATE 127 ROUND	BPW
SACBPWAS0312		AFTERMARKET Z-SPRING CLAMP PLATE R/H 120MM	BPW
SACBPWAS0312A		AFTERMARKET Z-SPRING CLAMP PLATE L/H 120MM	BPW
SACBPWAS0311		AFTERMARKET LEAF SPRING/AXLE CLAMP PLATE	BPW

SUSPENSION



SAC NO.	IMAGE	DESCRIPTION	SUITABLE FOR I.E.
SACBPWAS0311A		AFTERMARKET LEAF SPRING/AXLE CLAMP PLATE	BPW
S220009		OE TRAILING ARM AIR CLAMP PLATE R/H	WEWELER
SACTRAIL0072		AFTERMARKET LEAF SPRING AXLE SEAT	AFRIT
SACTQ10118		AFTERMARKET SUSPENSION CLAMP PLATE ROUND	HENRED
SACTQ10023		AFTERMARKET SUSPENSION CLAMP PLATE 16MM	HENRED
SACTQ09024		AFTERMARKET CLAMP PLATE H2 BOGIE	HENRED
ROCKER BOX			
SACTRAILBOM01		AFTERMARKET ROCKER BOX ASSEMBLY	HENRED
SACTQ10003		AFTERMARKET ROCKER BOX	HENRED

SUSPENSION



SAC NO.	IMAGE	DESCRIPTION	SUITABLE FOR I.E.
SACTQ10028		AFTERMARKET ROCKER BOX BOSS F/J SERIES	HENRED
SACBPWR001A		OE ROCKER BOX 10TON	BPW
300.361		AFTERMARKET ROCKER BOX 10TON	BPW
SACTQ25020		AFTERMARKET ROCKER BOX	AFRIT
SACTQ20001		AFTERMARKET ROCKER BOX	SWIFT
SACTQ18012		AFTERMARKET ROCKER BOX PIN 50.8 X 284MM	HENRED
SACBIG0003		AFTERMARKET ROCKER BOX PIN 50.8 X 284MM	HENRED
TRS4322		AFTERMARKET ROCKER BOX PIN 50.8 X 284MM	HENRED

SUSPENSION



SAC NO.	IMAGE	DESCRIPTION	SUITABLE FOR I.E.
TRS4702		AFTERMARKET ROCKER BOX PIN 57 X 50 X 232MM	BPW
SACTQ24101		AFTERMARKET ROCKER BOX PIN 57 X 50 X 232MM	BPW
RADIUS ROD			
SACTQ22029		AFTERMARKET RADIUS ROD ADJUSTABLE 580MM	SWIFT
SACTQ22033		AFTERMARKET RADIUS ROD FIXED 580MM	SWIFT
SACTQ25007		AFTERMARKET RADIUS ROD FIXED LONG	HENRED/YORK
SACTQ10009		AFTERMARKET RADIUS ROD ADJUSTABLE	HENRED
SACTQ10008		AFTERMARKET RADIUS ROD FIXED F3 SHORT	HENRED
SACBPWAS0170A		OE TORQUE ARM ADJUSTABLE 425MM	BPW

SUSPENSION



SAC NO.	IMAGE	DESCRIPTION	SUITABLE FOR I.E.
300.160		AFTERMARKET RADIUS ROD FIXED 475MM	BPW
SACBPWAS0170B		OE TORQUE ARM FIXED 475MM	BPW
SACTRAIL0011		AFTERMARKET RADIUS ROD PIN	HENRED
780.116		AFTERMARKET RADIUS ROD PIN	HENRED
HANGERS			
SACTQ09008		AFTERMARKET SPRING HOOD ASSEMBLY H2 BOGIE	HENRED
SACCROS014		AFTERMARKET T - RUBBER H2 BOGIE	HENRED
SACTRAIL0081		AFTERMARKET FRONT HANGER	AFRIT
300.393		AFTERMARKET HANGER BRACKET	BPW

SUSPENSION



SAC NO.	IMAGE	DESCRIPTION	SUITABLE FOR I.E.
SACBPW04003B		AFTERMARKET HANGER BRACKET FIXED	BPW
SACBPW0403B		OE HANGER BRACKET	BPW
SACBPWAS0400		OE HANGER BRACKET BOLT ON	BPW
SACBPWAS0400A		OE HANGER BRACKET R/H	BPW
SACBPWAS0400B		OE HANGER BRACKET L/H	BPW
880.001		AFTERMARKET HANGER BRACKET	HENRED / WEWELER
SACTQ10303		AFTERMARKET HANGER BRACKET	HENRED / WEWELER
SACTQ10002		AFTERMARKET HANGER BRACKET REAR F-SERIES	HENRED

SUSPENSION



SAC NO.	IMAGE	DESCRIPTION	SUITABLE FOR I.E.
SACTRAIL0058		AFTERMARKET HANGER BRACKET FRONT/STRAIGHT 1/2	HENRED
SACTQ10000		AFTERMARKET HANGER BRACKET F-SERIES	HENRED
SACTQ10051		AFTERMARKET HANGER BRACKET CENTRE SHORT	HENRED
400.082		AFTERMARKET HANGER BRACKET F SERIES	HENRED
400.083		AFTERMARKET HANGER BRACKET FRONT TAPER	HENRED
WEAR PLATE			
SACTQ10014		AFTERMARKET LEAF SPRING WEAR PLATE F-SERIES	HENRED
SACTQ10034A		AFTERMARKET WEAR PLATE SPACER TUBE	HENRED
120.435		AFTERMARKET LEAF SPRING WEAR PLATE	HENRED

SUSPENSION



SAC NO.	IMAGE	DESCRIPTION	SUITABLE FOR I.E.
SACTQ22004		AFTERMARKET LEAF SPRING WEAR PLATE 90MM ID	SWIFT
SACBPW-005		OE LEAF SPRING WEAR PLATE	BPW
SACTQ10302		AFTERMARKET LEAF SPRING WEAR PLATE	HENRED / WEWELER
SACTQ10301		AFTERMARKET WEAR PLATE AIR SUSPENSION	HENRED / WEWELER
100.027		OE AFTERMARKET WEAR PLATE AIR SUSPENSION	HENRED / WEWELER
SACBPWAS0403A		OE Z-SPRING WEAR PLATE M30 FLAT SHAPE	BPW
SACBPWAS0403C		OE Z-SPRING WEAR PLATE M30 FLAT SHAPE	BPW
300.419		AFTERMARKET Z-SPRING WEAR PLATE M24 OFFSET SHAPE	BPW

SUSPENSION



SAC NO.	IMAGE	DESCRIPTION	SUITABLE FOR I.E.
300.525		AFTERMARKET Z-SPRING WEAR PLATE M30 FLAT SHAPE	BPW
SACBPWAI002		OE TRACKING PLATE 235 X 98 X 5 WITH DOWEL	BPW
SACBPWAI002B		AFTERMARKET TRACKING PLATE 235 X 98 X 5 WITH OUT DOWEL	BPW
SACBPWAS0310		OE TRACKING PLATE DOWEL PIN 24DIA X 23L	BPW
BUSHES			
300.330		AFTERMARKET TRAILING ARM BUSH 30 X 57 X 102MM	BPW
300.323		AFTERMARKET SPRING BLADE BUSH 30 X 72 X 60MM SHORT	BPW
1016273		AFTERMARKET TRAILING ARM BUSH 30 X 60 X 72 MM SHORT	BPW
1016272		AFTERMARKET TRAILING ARM BUSH 24 X 60 X 72 MM	BPW

SUSPENSION



SAC NO.	IMAGE	DESCRIPTION	SUITABLE FOR I.E.
1016276		AFTERMARKET FRONT LEAF SPRING BUSH 80 X 25 X 80	BPW
SACT075.020		AFTERMARKET Z-SPRING BUSH 30 X 68 X 104MM	HOLLAND
SACTQ24310		AFTERMARKET TRAILING ARM BUSH STEEL M30 X 57 X 102MM	BPW
SACTRAIL0074		AFTERMARKET FRONT/REAR TRAILING ARM BUSH STEEL	AFRIT
300.331		AFTERMARKET ROCKER BOX BUSH 50 X 100 X 130MM	BPW
TRB7001		AFTERMARKET RADIUS ROD BUSH 22 X 59 X 58MM	YORK
SACBPWS113B		OE RADIUS ROD BUSH M36 X 66 X 68	BPW
SACBPW-006		OE ROCKER BOX BUSH 50 X 100 X 130MM	BPW

SUSPENSION



SAC NO.	IMAGE	DESCRIPTION	SUITABLE FOR I.E.
1016211		AFTERMARKET RADIUS ROD BUSH M30 X 60 X 68	BPW
SACBPW0122		AFTERMARKET ROCKER BOX BUSH 50 X 100 X 130MM	BPW
1036400		AFTERMARKET TRAILING ARM BUSH 31.5 X 114 X 155MM	SAF
SACTRAIL526		SAF OE LEAF SPRING RUBBER BUSH	HOLLAND
SACTQ21002		AFTERMARKET TRUNNION BUSH 11 X 120 X 200MM	SWIFT
SACTRAIL0017		AFTERMARKET CROSS SHAFT BUSH H2 BOGIE	HENRED
SAC02BH004T		AFTERMARKET RADIUS ROD BUSH CLEAR	HENRED
SACTQ10015C		AFTERMARKET ROCKER BOX BUSH CLEAR	HENRED









SUSPENSION



SAC NO.	IMAGE	DESCRIPTION	SUITABLE FOR I.E.
SACBPWAS0404		OE PIVOT BOLT BUSH 92 X 62 X 29	BPW
300.231		AFTERMARKET PIVOT BOLT BUSH 92 X 62 X 29	BPW
SACMISC047-1		OE TRAILING ARM BUSH 29 X 30.5 X 56 STEEL	BPW
SACMISC047A		OE TRAILING ARM BUSH STEEL	BPW
SACMISC047-2		OE TRAILING ARM BUSH 30/55/60 X 24/20 STEEL	BPW
SACBPWAS1536		OE HANGER BRACKET BUSH M24	BPW
SACBPWAS1535		OE HANGER BRACKET BUSH M30	BPW
SACBPWAS0403AA		OE PIVOT BOLT ADJUSTMENT PLATE	BPW







SUSPENSION



SAC NO.	IMAGE	DESCRIPTION	SUITABLE FOR I.E.
U-BOLT			
SACTQ10007		AFTERMARKET U-BOLT 8 BLADE M22X2.5XL332X80MM	HENRED
SACTQ10027		AFTERMARKET U-BOLT 9 BLADE M22 X2.5XL370X80MM	HENRED
SACTQ10031		AFTERMARKET U-BOLT 10 BLADE M22 X L420 X 80	HENRED
SACTRAIL0146		AFTERMARKET U-BOLT M24 X 2.0 X 294 X 146	HENRED / WEWELER
SACUBOLTWEW		AFTERMARKET U-BOLT M24 X 2 X L320 X 130	WEWELER
SACTQ09003		AFTERMARKET U-BOLT M24 X 2 X L320 X 130	WEWELER
SACTQ20016		AFTERMARKET U-BOLT U-SERIES M22 X 1.5 X L325 X 129	ROR
SACTQ20027		AFTERMARKET U-BOLT U-SERIES M22 X 1.5 X L450 X 129	ROR

SUSPENSION



SAC NO.	IMAGE	DESCRIPTION	SUITABLE FOR I.E.
SACTQ20028		AFTERMARKET U-BOLT M22 X 1.5 L370 I/D129	WEWELER
SACTRAIL0077		AFTERMARKET FRONT REAR AXLE LEAF SPRING U-BOLT WITH NUT	BPW
1016305		AFTERMARKET U-BOLT M24 X 3 X L320 X 128	BPW
SACBPWAS0319		OE U-BOLT M24 X 3 X L280 X 101	BPW
SACBPWAS0319AB		AFTERMARKET U-BOLT M24 X 3 X L280 X 129	BPW
SACBPWS119		OE U-BOLT M24 X 3 X L277 X 128	BPW
SACBPWS119A		OE U-BOLT M24 X L300 X 138	BPW
300.108C		AFTERMARKET U-BOLT M24 X 3 X 280 X 101 C\W WITH NUTS & WASHERS	BPW

SUSPENSION



SAC NO.	IMAGE	DESCRIPTION	SUITABLE FOR I.E.
S200002VA		AFTERMARKET U-BOLT M24 X 300 X 138	BPW
1016322		AFTERMARKET U-BOLT M24 X 3 X 280 X 129	BPW
SACTRAIL0068		AFTERMARKET U-BOLT M24 X 3 X 280 X 129	BPW
1016300		AFTERMARKET U-BOLT M24 X 3 X L280 X 101	BPW
1016301		AFTERMARKET U-BOLT M24 X L320 X 101	BPW
SACTQ10005		AFTERMARKET U-BOLT STRONG BACK 80MM	HENRED
SACBPWAS0308A		AFTERMARKET U-BOLT STRONG BACK 95 X 45 X 34MM	BPW
SACBPWAS074		OE U-BOLT STRONG BACK 122 X 41 X 44MM	BPW

SUSPENSION



SAC NO.	IMAGE	DESCRIPTION	SUITABLE FOR I.E.
300.403		AFTERMARKET U-BOLT STRONG BACK 95 X 45 X 34MM	BPW
300.404		AFTERMARKET U-BOLT STRONG BACK 122 X 41 X 44MM	BPW
FASTENERS & CONNECTORS			
SACMISC047D		OE TRAILING ARM PIVOT BOLT M24 ROUND HEAD	BPW
SACTRAIL0053		AFTERMARKET FRONT/REAR TRAILING ARM PIVOT BOLT COMPLETE	BPW
SACT0003		OE TRAILING ARM BOLT M30 X 200	BPW
SACMISC047B		OE TRAILING ARM BOLT KIT M24 X 165	BPW
SACTRAIL0054		AFTERMARKET TRAILING ARM PIVOT BOLT ADJUSTABLE SHORT	BPW
SACBPW0120		AFTERMARKET TRAILING ARM BOLT KIT M24 X 165	BPW

SUSPENSION



SAC NO.	IMAGE	DESCRIPTION	SUITABLE FOR I.E.
SACTRAIL0018		OE TRAILING ARM BOLT KIT M30 X 200 PRICE X1PC	BPW
SACBOLT30X220		OE TRAILING ARM BOLT M30 X 220/8.8	BPW
1016255		AFTERMARKET TRAILING ARM BOLT M30 X 3 X 210MM	BPW
SACTQ10202		AFTERMARKET TRAILING ARM BOLT M30 X 197MM	HENRED / WEWELER
M30250		AFTERMARKET TRAILING ARM BOLT M30 X 265MM	BPW
100.031		AFTERMARKET TRAILING ARM BOLT 30 X 19	HENRED / WEWELER
SACTRAIL1044		OE TRAILING ARM BOLT M30 X 240MM	HENRED / WEWELER
SACMISC047C		OE TRAILING ARM BOLT M30 X 265MM	BPW

SUSPENSION



SAC NO.	IMAGE	DESCRIPTION	SUITABLE FOR I.E.
SACTRAIL0078		AFTERMARKET FRONT/REAR TRAILING ARM PIVOT BOLT COMPLETE	AFRIT
SACTRAIL0079		AFTERMARKET FRONT/REAR TRAILING ARM PIVOT BOLT COMPLETE	AFRIT
SACTRAIL0080		AFTERMARKET FRONT/REAR TRAILING ARM PIVOT BOLT COMPLETE	AFRIT
SACTRAIL0052		AFTERMARKET TRAILING ARM BOLT M30 X 200MM	BPW
SACMISC059A		AFTERMARKET TRAILING ARM CENTRE BOLT M16 X 110MM	BPW
SACBOLT30X210		OE TRAILING ARM BOLT M30 X 210/8.8MM	BPW
300.241		AFTERMARKET TRAILING ARM BOLT M30 X 210/8.8MM	BPW
SACBPWAS073		AFTERMARKET CHASSIS SHOCK BOLT M24 X 275MM	BPW



SUSPENSION



SAC NO.	IMAGE	DESCRIPTION	SUITABLE FOR I.E.
SACTRAIL1000		OE SHOCK BOLT M20 X 2 X 175	HENRED
SACTRAIL1001		OE SHOCK BOLT M20 X 2 X 240	HENRED / WEWELER
SACTQ27001		AFTERMARKET LEAF SPRING CENTRE BOLT M14 X 145 WITH NUT	HENRED
SACTQ27007		AFTERMARKET LEAF SPRING CENTRE BOLT M14 X 290 WITH NUT	HENRED
SACTQ27011		AFTERMARKET Z-SPRING BOLT M16 X 77MM	HENRED / WEWELER
200.100		JOST AFTERMARKET KING PIN BOLT FLANGE TYPE	MULTIBRAND
SACJOSK006		JOST OE KING PIN BOLT FLANGE TYPE	JOST
SACTQ30070		AFTERMARKET KING PIN BOLT FLANGE TYPE	JOST

SUSPENSION



SAC NO.	IMAGE	DESCRIPTION	SUITABLE FOR I.E.
SACTRAIL503		AFTERMARKET KING PIN BOLT FLANGE TYPE	JOST
200.507		5TH WHEEL WEARING RING BOLT 36C/37C	MULTIBRAND
200.516		5TH WHEEL TOP WEAR RING BOLT	MULTIBRAND
SACJOST011		JOST 5TH WHEEL WEARING RING BOLT 36C/37C	MULTIBRAND
SACJOST016		JOST 5TH WHEEL HOLD DOWN BOLT	MULTIBRAND
SACTQ08041		AFTERMARKET SPIDER BRACKET BOLT M14 X 65MM	HENRED
SACTQ08041A		AFTERMARKET SPIDER BRACKET BOLT M12 X 65MM	HENRED
SACTQ10034		WEAR PLATE HEX BOLT M16 X 150	HENRED







SUSPENSION



SAC NO.	IMAGE	DESCRIPTION	SUITABLE FOR I.E.
SACTRAIL290		AFTERMARKET FRONT LEAF SPRING U-BOLT NUT	HENRED / WEWELER
SACTRAIL1045		OE TRAILING ARM NUT M27 X 2.8	HENRED / WEWELER
SACBPWR002B		OE ROCKER BOX PIN LOCK NUT	BPW
SACTQ24007		AFTERMARKET ROCKER PIN LOCK NUT	BPW
300.547		AFTERMARKET ROCKER BOX PIN LOCK NUT 42 X 3	BPW
FW2		AFTERMARKET KING PIN NUT	JUST
SACTRAIL1002		OE SHOCK BOLT NUT M20	HENRED
SACFSER009		OE U-BOLT WASHER 25 X 43.5 X 3.5	BPW

SUSPENSION

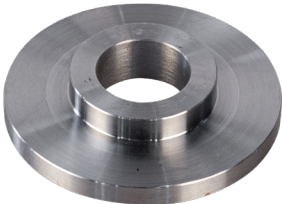

SAC NO.	IMAGE	DESCRIPTION	SUITABLE FOR I.E.
SACTRAIL291		AFTERMARKET U-BOLT WASHER M24	HENRED / WEWELER
600.184		AFTERMARKET U-BOLT WASHER 25 X 43.5 X 3.5	BPW
SACTRAIL4042		OE HANGER BOLT WASHER 31 X 57 X 5	BPW
1036266		AFTERMARKET TRAILING ARM TEFLON WASHER 60.5 X 170 X 4.75	HOLLAND
SACTRAIL1046		OE TRAILING ARM WASHER M30	HENRED / WEWELER
SACTRAIL0076		AFTERMARKET LEAF SPRING WASHER	AFRIT
LANDING LEG			
SAC205T00000		OE LANDING LEG KIT T-TYPE	MULTIBRAND
SACE112T48002		OE LANDING LEG KIT T-TYPE	JOST

CHASSIS



SAC NO.	IMAGE	DESCRIPTION	SUITABLE FOR I.E.
LANDING LEG			
SACA402G1926LH		OE LANDING LEG L/H G-TYPE	BPW
SACE112A48002		OE LANDING LEG KIT E-TYPE	JOST
SACTRAIL0057		LANDING LEG R/H GEAR BOX	MULTIBRAND
SACJOLL024		OE LANDING LEG CONNECT SHAFT	JOST
SACJOLL028A		LANDING LEG CRANK HANDLE	MULTIBRAND
5TH WHEEL			
SACJSK37C		5TH WHEEL 37C 185MM	MULTIBRAND
SACJSK37CJE7		5TH WHEEL 37C JE7 185MM PEDESTAL	MULTIBRAND
SACMUL046		5TH WHEEL 37C SAC 185MM PEDESTAL	MULTIBRAND

CHASSIS



SAC NO.	IMAGE	DESCRIPTION	SUITABLE FOR I.E.
SACJSK38C		OE 5TH WHEEL 38C 2"	JOST
SACJOST006		5TH WHEEL LEVER 36C	MULTIBRAND
SACJOSW006		5TH WHEEL LEVER 37C	MULTIBRAND
SACJOST008		BOLT & NUT 5TH WHEEL LEVER	MULTIBRAND
SACJOST007		5TH WHEEL OPERATING HANDLE 36C	MULTIBRAND
SACJOSW007		5TH WHEEL OPERTATING HANDLE 37C	MULTIBRAND
SACJOSW028		5TH WHEEL LATCH COMPLETE	MULTIBRAND
200.506		5TH WHEEL WEARING RING 36C/37C	MULTIBRAND

CHASSIS



SAC NO.	IMAGE	DESCRIPTION	SUITABLE FOR I.E.
SACJOST010		5TH WHEEL WEARING RING 36C/37C	MULTIBRAND
200.514		5TH WHEEL WEARING RING FIXTURE	MULTIBRAND
SACJOSW011		5TH WHEEL WEARING RING FIXTURE	MULTIBRAND
SACSKS3620W		5TH WHEEL WEARING RING REPAIR KIT	MULTIBRAND
SACTRAIL1566		5TH WHEEL WEARING RING REPAIR KIT	MULTIBRAND
200.515		5TH WHEEL WEARING RING INSERT	MULTIBRAND
SACJOSW010		5TH WHEEL WEARING RING INSERT	MULTIBRAND
SACKIT-36C-M		5TH WHEEL REPAIR KIT WITHOUT LEVER & HANDLE	MULTIBRAND

CHASSIS



SAC NO.	IMAGE	DESCRIPTION	SUITABLE FOR I.E.
SACKIT-37C-M		5TH WHEEL REPAIR KIT WITHOUT LEVER & HANDLE	MULTIBRAND
SACKIT37CMA1		5TH WHEEL REPAIR KIT WITH LEVER & HANDLE	MULTIBRAND
SACKIT37CMJE7B		5TH WHEEL KIT MAJOR 37C JE7+BEARING	MULTIBRAND
SACKIT37C-M-JE7		AFTERMARKET 5TH WHEEL KIT MAJOR 37C JE7 JSK37C-C1	MULTIBRAND
200.505		5TH WHEEL LOCK JAW 37C	MULTIBRAND
SACJOST001		5TH WHEEL LOCK JAW 36C	MULTIBRAND
SACJOSW004		5TH WHEEL LOCKING BAR BOLT 36C	MULTIBRAND
SACTQ26004		5TH WHEEL LOCKING BAR 36C	MULTIBRAND









CHASSIS

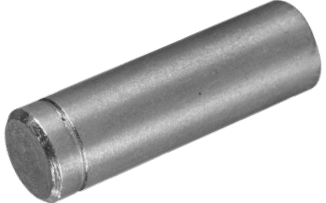

SAC NO.	IMAGE	DESCRIPTION	SUITABLE FOR I.E.
SACJOSW005		5TH WHEEL LOCKING BAR BOLT COMPLETE 37C	MULTIBRAND
SACJOST013A		5TH WHEEL UPPER RUBBER CUSHION 36C/37C	MULTIBRAND
SACJOST014B		5TH WHEEL LOWER RUBBER CUSHION 36C/37C	MULTIBRAND
MGSP5		5TH WHEEL LOWER RUBBER CUSHION 36C/37C	MULTIBRAND
MGSP6		5TH WHEEL UPPER RUBBER CUSHION 36C/37C	MULTIBRAND
SACTRAIL0048		5TH WHEEL TOP PLATE LINER R/H	MULTIBRAND
SACTRAIL0049		5TH WHEEL TOP PLATE LINER L/H	MULTIBRAND
SACLINER		5TH WHEEL PROTECTOR 965 X 73 X 5MM	MULTIBRAND

CHASSIS



SAC NO.	IMAGE	DESCRIPTION	SUITABLE FOR I.E.
SACJOST005A		5TH WHEEL LOCKING BAR BOLT 36C	MULTIBRAND
SACJOST003		5TH WHEEL LOCK JAW PIVOT PIN 36C	MULTIBRAND
200.508		5TH WHEEL LOCK JAW PIVOT PIN 37C	MULTIBRAND
200.509		5TH WHEEL LOCK JAW SPRING 37C	MULTIBRAND
SACJOST002		5TH WHEEL LOCK JAW SPRING 37C	MULTIBRAND
SACJOST009		5TH WHEEL DOUBLE TENSION SPRING SHORT 36C	MULTIBRAND
SACJOSW009		5TH WHEEL DOUBLE TENSION SPRING SHORT 37C	MULTIBRAND
SACJOST018		5TH WHEEL SPRING HOOK AND CHAIN 36C	MULTIBRAND

SAC NO.	IMAGE	DESCRIPTION	SUITABLE FOR I.E.
KING PIN			
SACJOSK004		OE KING PIN FLANGE TYPE OLD	JUST
SACJOSK004AA		OE KING PIN FLANGE TYPE NEW 2" 37C	JUST
SACJOSK009A		OE KING PIN FLANGE TYPE 2" 37C COMPLETE	JUST
200.203		AFTERMARKET KING PIN FLANGE TYPE NEW 2" 37C	JUST
200.204		AFTERMARKET KING PIN FLANGE TYPE NEW 3" 38C	JUST
200.549		AFTERMARKET KING PIN FLANGE TYPE 2" 37C COMPLETE	JUST
200.555		AFTERMARKET KING PIN FLANGE TYPE OLD	JUST
SACTQ03065		AFTERMARKET KING PIN FLANGE TYPE NEW 2" 37C	JUST

CHASSIS



SAC NO.	IMAGE	DESCRIPTION	SUITABLE FOR I.E.
SACTRAIL504		AFTERMARKET KING PIN FLANGE TYPE NEW 2 IN 37C	JOST
SACJOSK002A		OE KING PIN BLOCK	JOST
SACTQ30051		KING PIN BLOCK 2INCH	BPW
SACJOSK001A		OE KING PIN AND NUT	JOST
FW4		AFTERMARKET KING PIN	JOST
SACTQ30050		AFTERMARKET KING PIN WITH NUT 2INCH	JOST

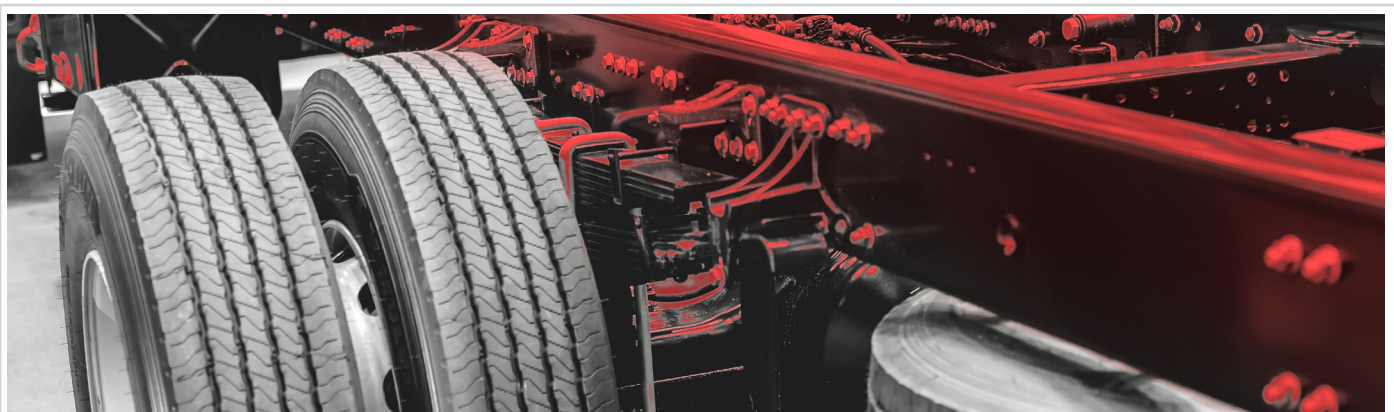

SHOCKS



SAC NO.	IMAGE	DESCRIPTION	SUITABLE FOR I.E.
P5202A		AFTERMARKET CHASSIS SHOCK 24 X 500	BPW
SACTQ24407		AFTERMARKET CHASSIS SHOCK 24 X 500	BPW
SACTQ10203		AFTERMARKET CHASSIS SHOCK LONG 20 X 470	HENRED / WEWELER
SACTQ10204		AFTERMARKET CHASSIS SHOCK SHORT 20 X 375	HENRED / WEWELER
SACTRAIL0070		AFTERMARKET CHASSIS SHOCK	AFRIT
SACTRAIL516		SAF OE FRONT/REAR SHOCK	HOLLAND
SACTRAIL517		SAF OE FRONT/REAR SHOCK	HOLLAND
SACTRAIL518		SAF OE FRONT/REAR SHOCK	HOLLAND

UNIVERSAL



RELATED COMPONENTS

UNIVERSAL

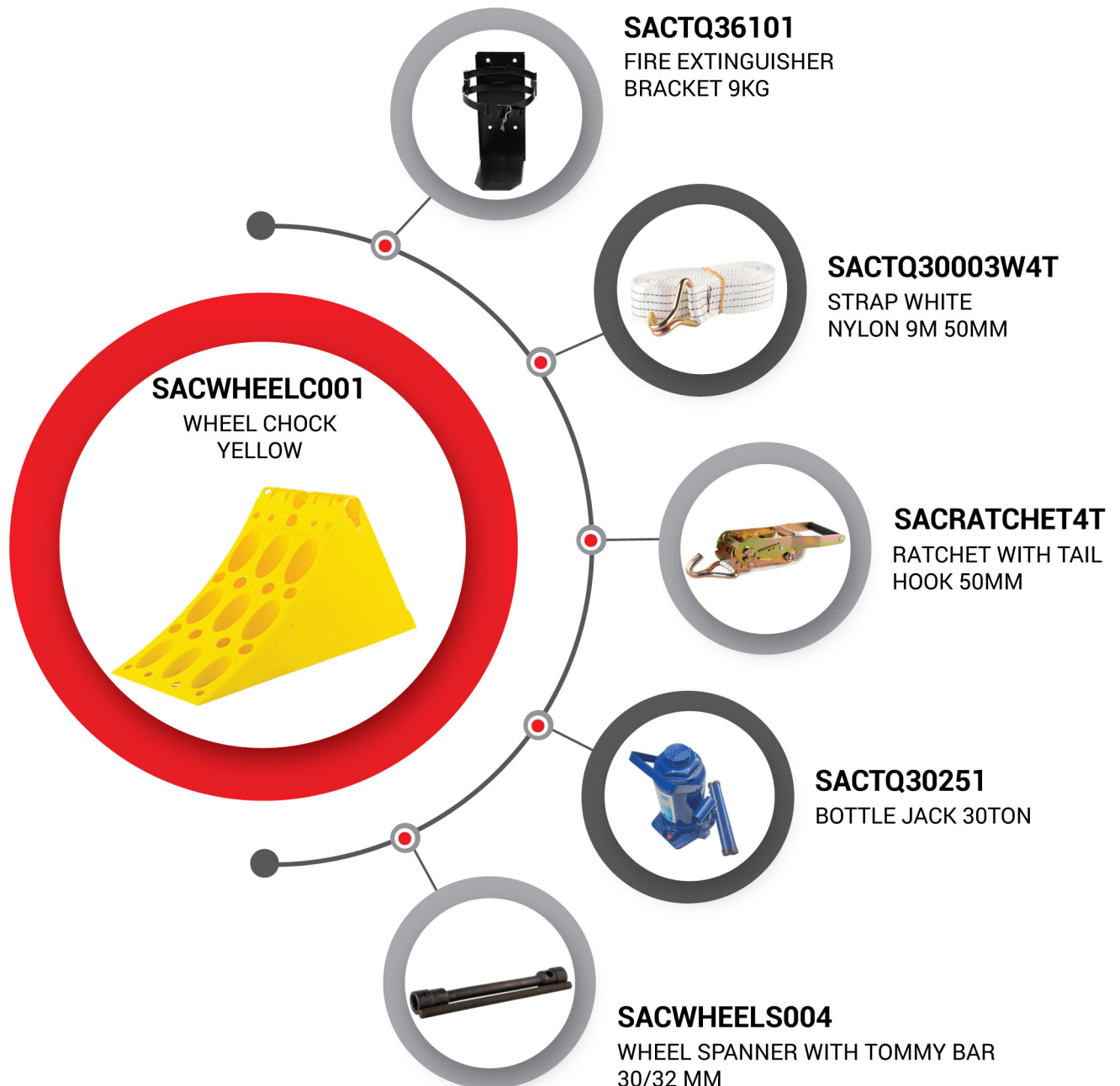

SAC NO.	IMAGE	DESCRIPTION	SUITABLE FOR I.E.
SACAR2880		WARNING TRIANGLE BIG	UNIVERSAL
SACTQ28042C		80KM REFLECTIVE STICKER	UNIVERSAL
SACELEC007B		REFLECTIVE TAPE WHITE P/M	UNIVERSAL
SACELEC007C		REFLECTIVE TAPE RED P/M	UNIVERSAL
SACTRAIL0059		REFLECTIVE TAPE YELLOW P/M	UNIVERSAL
SACMUL028		CHEVRON HONEYCOMB 1.2M 195WIDE	UNIVERSAL
SACCHEV1700HC		CHEVRON BOARD STEELE 1.7M	UNIVERSAL
SACCHEV1700HD		CHEVRON STICKER 1.7M	UNIVERSAL

SAC NO.	IMAGE	DESCRIPTION	SUITABLE FOR I.E.
SACTQ28046A		ROUND REFLECTOR AMBER 760D METAL FLANGE	UNIVERSAL
SACTQ28044R		ROUND REFLECTOR RED 760D METAL FLANGE	UNIVERSAL
SACLIGH043		ROUND REFLECTOR WHITE 760D METAL FLANGE	UNIVERSAL
SACMUL024		METAL REFLECTOR AMBER 2 PIECE 50MM	UNIVERSAL
SACMUL025		AMBER ADHESIVE REFLECTOR 35X65MM	UNIVERSAL
SACMUL026		CLEAR ADHESIVE REFLECTOR 35 X 65MM	UNIVERSAL
SACMUL027		RED ADHESIVE REFLECTOR 35 X 65MM	UNIVERSAL
SACREFS01		RED ADHESIVE REFLECTOR STICK ON 40 X 90MM	UNIVERSAL







SAC NO.	IMAGE	DESCRIPTION	SUITABLE FOR I.E.
SACREFS02		STICK ON REFLECTOR AMBER	UNIVERSAL
SACTQ36100		FIRE EXTINGUISHER 9KG	UNIVERSAL
SACTRAIL36100		FIRE EXTINGUISHER 4.5KG	UNIVERSAL
SACTRAIL1KG		FIRE EXTINGUISHER WITH BRACKET 1KG	UNIVERSAL
SACTQ36101		FIRE EXTINGUISHER BRACKET 9KG	UNIVERSAL
SACTRAIL36101		FIRE EXTINGUISHER BRACKET 4.5KG	UNIVERSAL
SACTRAIL9KG		FIRE EXTINGUISHER BOX 9KG	UNIVERSAL
SACTRAIL52		FIRE EXTINGUISHER BOX RED DIAMOND/BLACK	UNIVERSAL



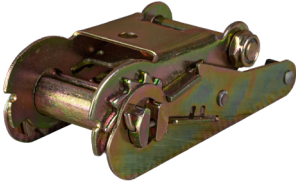
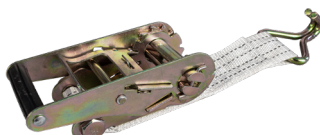



SAC NO.	IMAGE	DESCRIPTION	SUITABLE FOR I.E.
S970033		TOOLBOX DAKEN 830 X 500 X 470 PLASTIC	UNIVERSAL
TOOLBOX1030		TOOLBOX DAKEN 1030 X 500 X 480	UNIVERSAL
SACWHEELS003		WHEEL SPANNER 30/33 MM	UNIVERSAL
SACWHEELS004		WHEEL SPANNER WITH TOMMY BAR 30/32MM	UNIVERSAL
SACWHEELS001		WHEEL SPANNER WITH T-BAR 30/27MM	UNIVERSAL
SACWHEELS002		WHEEL SPANNER WITH T-BAR 21/38MM	UNIVERSAL
SACUNI00001		WHEEL SPANNER 35/17 MM	UNIVERSAL
SACWHEELS005		WHEEL SPANNER WITH T-BAR 21/41MM	UNIVERSAL

SAC NO.	IMAGE	DESCRIPTION	SUITABLE FOR I.E.
SACWHEELS004WO		WHEEL SPANNER WITHOUT TOMMY BAR 30/32	UNIVERSAL
SACTQ30082		TOMMY BAR WHEEL SPANNER	UNIVERSAL
SACTRAIL0062		TOMMY BAR WHEEL SPANNER	UNIVERSAL
SACWHEELC001		WHEEL CHOCK YELLOW	UNIVERSAL
SACWHEELC002		WHEEL CHOCK YELLOW 20TON	UNIVERSAL
S970032		RUBBER WHEEL CHOCK 5TON	UNIVERSAL
SACMISC017H		WHEEL CHOCK HOLDER	UNIVERSAL
SACJACK20T		BOTTLE JACK 20TON	UNIVERSAL

SAC NO.	IMAGE	DESCRIPTION	SUITABLE FOR I.E.
VJ1020		BOTTLE JACK 20TON	UNIVERSAL
SACTQ30251		BOTTLE JACK 30TON	UNIVERSAL
SACJACK32T		BOTTLE JACK 32TON	UNIVERSAL
SACJACK50T		BOTTLE JACK 50TON	UNIVERSAL
SACTQ30252		BOTTLE JACK 50TON	UNIVERSAL
SACJ-STAND3T		JACK STAND 3TON	UNIVERSAL
SACREVBUZ01		REVERSE ALARM 12-48V	UNIVERSAL
SACJ-BOX		ELECTRICAL JUNCTION BOX	UNIVERSAL

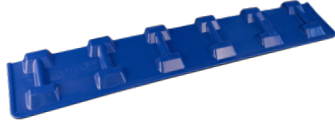
SAC NO.	IMAGE	DESCRIPTION	SUITABLE FOR I.E.
SACLW505		STRAP ORANGE 12M 50MM 5TON	UNIVERSAL
SACTQ30003		STRAP WHITE NYLON 12M 50MM	UNIVERSAL
SACTQ30003TQ		STRAP WHITE POLYESTER 12M 50MM	UNIVERSAL
SACTQ30003W4T		STRAP WHITE NYLON 9M 50MM	UNIVERSAL
SACLW0035TQ		STRAP ORANGE POLYESTER 9M 50MM 5TON	UNIVERSAL
SACLW0035T		STRAP ORANGE NYLON 9M 50MM 5TON	UNIVERSAL
SACTQ3003W3TQ		STRAP WHITE POLYESTER 9M 50MM	UNIVERSAL
SACTRAIL501SLP		STRAP WHITE NO HOOK/TIPPER BELT 50MM X 3M	UNIVERSAL

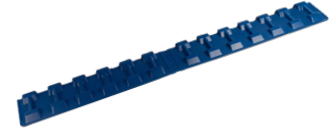

SAC NO.	IMAGE	DESCRIPTION	SUITABLE FOR I.E.
SACUNI00002		RATCHET SHORT HANDLE FOR SIDE TIPPER	UNIVERSAL
SACR802		RATCHET WITH TAIL HOOK SHORT HANDLE 50MM	UNIVERSAL
SACRACHET3TQ		RATCHET WITH TAIL HOOK POLYESTER 50MM	UNIVERSAL
SACRACHET4TQ		RATCHET WITH TAIL HOOK POLYESTER 50MM	UNIVERSAL
SACRACHET5T		RATCHET WITH TAIL HOOK 50MM	UNIVERSAL
SACRACHET5TQ		RATCHET WITH TAIL HOOK POLYESTER 50MM	UNIVERSAL
SACRACHET4T		RATCHET WITH TAIL HOOK 50MM	UNIVERSAL
SACTQ30203		LOAD BINDER RATCHET TYPE 10MM	UNIVERSAL

SAC NO.	IMAGE	DESCRIPTION	SUITABLE FOR I.E.
SACTQ30204		CHAIN GRAB HOOK 10MM	UNIVERSAL
SACTQ30163		CHAIN FOR LOADBINDER 9M X 10MM	UNIVERSAL
SACTRAIL0010		CHAIN 6M X 10MM	UNIVERSAL
S980005		CARGO CORNER PIECE 1.2M	UNIVERSAL
SACTQ30007		CARGO CORNER PIECE 1.2M	UNIVERSAL
SACTRAIL0060		CARGO CORNER PIECE 2.0M	UNIVERSAL
SACRUB0403		HENRED OE BUMBER D-RUBBER 1000MM	UNIVERSAL
SACTQ30240		LICENSE DISC HOLDER SINGLE	UNIVERSAL

SAC NO.	IMAGE	DESCRIPTION	SUITABLE FOR I.E.
SACCJ30241		LICENSE DISC HOLDER DOUBLE	UNIVERSAL
SACWT30		WHEEL CHECK POINT 30MM	UNIVERSAL
SACWT32		WHEEL CHECK POINT 32MM	UNIVERSAL
SACWT33		WHEEL CHECK POINT 33MM	UNIVERSAL
SACWT38		WHEEL CHECK POINT 38MM	UNIVERSAL
SACTQ30221		CONTAINER TWIST LOCK SINGLE	UNIVERSAL
SACTRAIL30219		CONTAINER TWIST LOCK DOUBLE	UNIVERSAL
SACTRAIL11		60L TANK STRAP 11 INCH	UNIVERSAL

SAC NO.	IMAGE	DESCRIPTION	SUITABLE FOR I.E.
SACTQ03028		NYLOC NUT M30	UNIVERSAL
1016283		LOCK NUT M30X3.5MM	UNIVERSAL
300.098		LOCK NUT M30X3.5MM	UNIVERSAL
SACCROS023BP		BPW OE U-BOLT LOCK NUT M24	UNIVERSAL
WN355		BPW AFTERMARKET U-BOLT LOCK NUT M24	UNIVERSAL
SACTQ03027		NYLOC NUT M24	UNIVERSAL
NLN113		NYLOC NUT M24	UNIVERSAL
SACTQ03026		NYLOC NUT M22	UNIVERSAL

SAC NO.	IMAGE	DESCRIPTION	SUITABLE FOR I.E.
SACTQ03023		NYLOC NUT M16	UNIVERSAL
SACTQ03022		NULOC NUT M14	UNIVERSAL
SACTQ03021		NYLOCK NUT M12	UNIVERSAL
SACTRAIL0047		ALUMINIUM WASHER 12MM	UNIVERSAL
SACFITW001		ALUMINIUM WASHER 14MM	UNIVERSAL
SACFITW002		ALUMINIUM WASHER 16MM	UNIVERSAL
SACTRAIL1010		BLANKING GROMMET RUBBER 21 X 30 X 34MM	UNIVERSAL
SACFITO005A		HOSE CLAMP 1/2	UNIVERSAL

SAC NO.	IMAGE	DESCRIPTION	SUITABLE FOR I.E.
SACMUL029		LOCK LOAD WINCH 5 INCHES	UNIVERSAL
SACVALVEX250		HENRED OE WHEEL EXTENSION FLEX VALVE 250MM	UNIVERSAL





Why Purchase Our Parts?

■ QUALITY

At SAC, quality is non-negotiable. We understand that to build a sustainable company that will carry into the next generation, the quality of the product must survive long after the pain of the purchase has faded away. Which is why developing lasting relationships with both local and global industry experts who can guarantee compatibility and availability of quality replacement parts is so important. Examples of such partnerships are the ones SAC has forged with Mansons in India as well as Diesel Technic (DT) in Germany; one of the largest suppliers of automotive parts and accessories in the world and a company that shares the same values regarding the importance of quality. We are proud to be the only DT Premium Partner in South Africa and one of only a handful in the world. All DT parts carry a 24-month warranty.

■ SERVICE

Our company is built on a philosophy of service excellence. This approach rings true for all levels of employees, including our management team. At SAC we literally eat, dream, sleep and breathe customer service. Everything we do is geared to ensure that our customers get their parts in the shortest possible time. You are welcome to put us to the test!

■ AVAILABILITY

SAC's objective is to stock a complete range of parts suitable for all leading European and Japanese heavy and medium commercial vehicles as well as batteries and lubricants for every application. That is why all 17 branches carry a wide range of stock on site. Stock levels are augmented by next-day-deliveries from our main Warehouse to the branches as well as a countrywide network of service providers to assist in the event of remote breakdowns.

■ COMPETITIVE PRICING

SAC has a robust procurement department that works non-stop to ensure that parts are sourced at best quality and price. They also receive regular feedback from the sales teams at the branches regarding parts that are not priced competitively. This information is passed on to our suppliers to ensure that our pricing continuously improves to benefit our customers without compromising on quality.

Please visit www.sactrucks.co.za to learn more about us.

FAQs

Where are the branches located?

We have 17 branches nationally, all conveniently located along the main routes of South Africa: Polokwane, Mbombela (Nelspruit), Durban, Middelburg, Pomona, Boksburg, Vereeniging, Alrode, Centurion, Klerksdorp, Welkom, Bloemfontein, Gqeberha (Port Elizabeth), Cape Town, Krugersdorp, Paarl and East London.

What are the business hours?

We are a 24/7 operation. Most of our branches are open to the public between 7h00 and 16h45 Mondays to Fridays and between 8h00 and 13h00 on Saturdays, but it is advisable to confirm with your nearest branch as times may vary. Outside of normal business hours we have teams on stand-by to assist in emergencies and further support is provided on a call-out basis as and when necessary.

Are replacement parts manufactured to OE specifications?

Both our local and overseas suppliers are sourced specifically with this in mind. Our parts also undergo rigorous testing and are certified accordingly.

Does SAC Commercial Parts provide any technical services or support?

Our in-house Brand Managers have vast industry experience and can address all your technical queries. We also have a state-of-the-art workshop in Centurion that services and repairs all large and medium European and Japanese commercial vehicles. We further engage in engineering and reconditioning, manufacturing, Dynamometer diagnostics as well as Injector refurbishment and testing.

What is the company's delivery policy?

We can and do accommodate our customers in this regard if it is economically feasible. In certain instances, we might arrange alternative delivery methods and timelines if the delivery address is remote or inaccessible.

Do parts come with a Guarantee?

Yes. Parts are tested internationally, but are guaranteed locally, for up to 24 months if you buy a Q+ battery or a part supplied by Diesel Technic, our long-standing distribution partner and a leading global supplier of quality replacement parts.



DISCLAIMER

Product availability is subject to change without notice. Whilst every effort is made to provide the most accurate, up-to-date product information, occasionally technical or typographical inaccuracies could occur. In certain instances, product images are for illustration purposes only and may possibly not be an exact representation of a product code.

SAC Commercial Parts Group does not accept responsibility or liability for any losses or damages of any kind arising from decisions made based on information contained here within. The onus is on the persons receiving the information to make their own determination as to a part's suitability prior to purchase.



www.sactrucks.co.za